



BRUKER AUTOMATED SERVICE HANDBOOK B.A.S.H.

Version 5.0

(© September, 2002; BRUKER BIOSPIN GMBH)



AQX/AQR Type Spectrometers

AQS Type Spectrometers

AVANCE:

OneBay { DPX

TwoBay { DRX
DSX
DMX

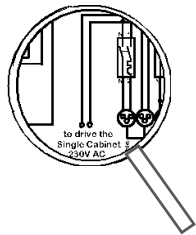

BLOCK
DIAGRAM

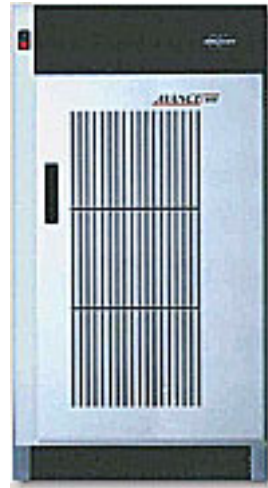

AVANCE AV with SGU:

AV { OneBay
MicroBay

AV { TwoBay

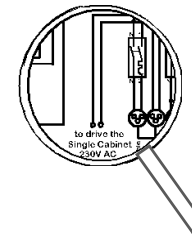

BLOCK
DIAGRAM

AVANCE Beginners Guide

Good Laboratory Practice

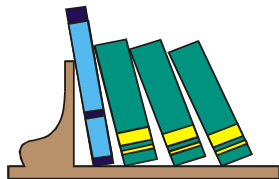

Using
BASH

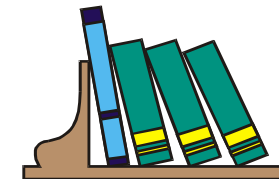

Manuals
List



AVANCE OneBay

General Description

ADDITIONAL MANUALS:

AVANCE Service Manual

Gradient Spectroscopy

RF Gradient Spectroscopy

GREAT 1

SE 451

B-HPCU

High Power

Power Router

Power Filter

Hardware Tests (HWT)

Site Planning 300-700 MHz

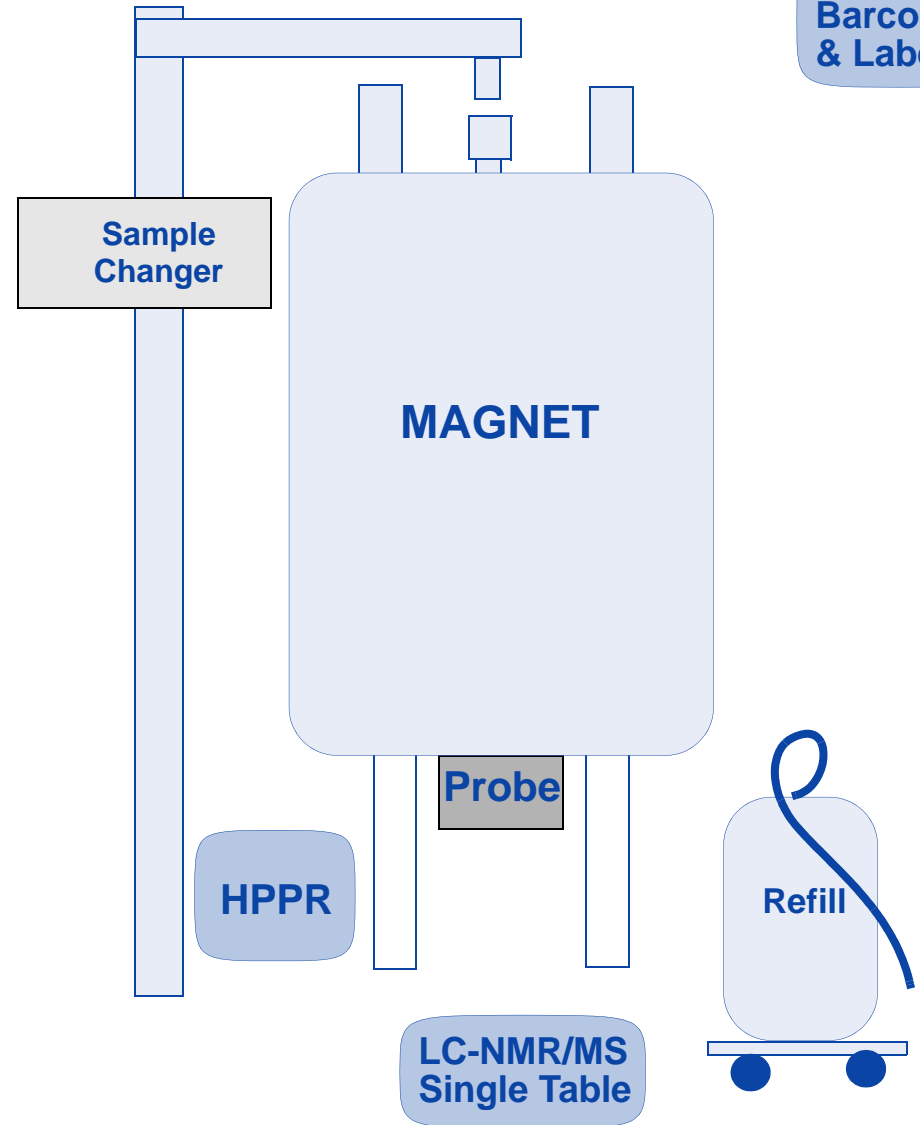
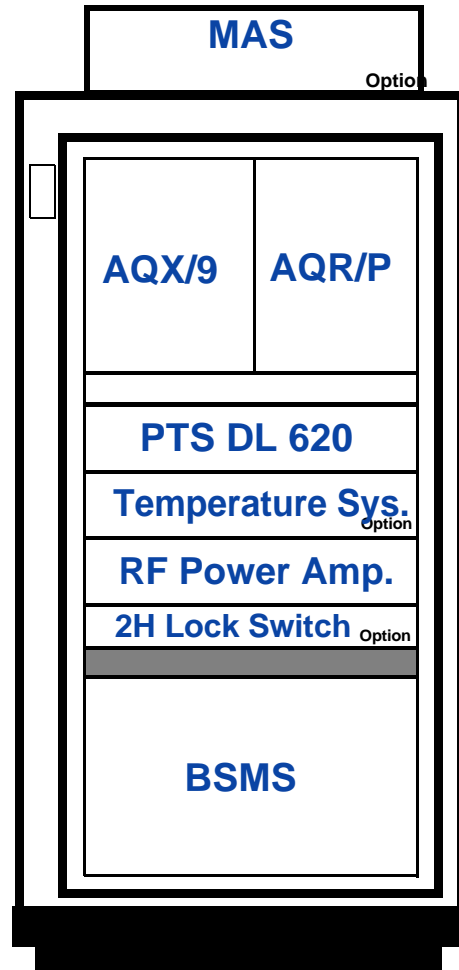

BEST,
Barcodes,
& Labels

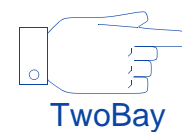
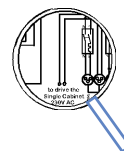
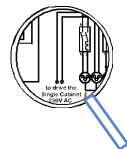

AVANCE OneBay: AQX/9 - AQR/P

ADDITIONAL MANUALS:

AQX/P Mainframe

AQR/P Mainframe

4-Phase Modulator

LOT

LOT/ASU/2

FTLP/4M

RXC

RDCU

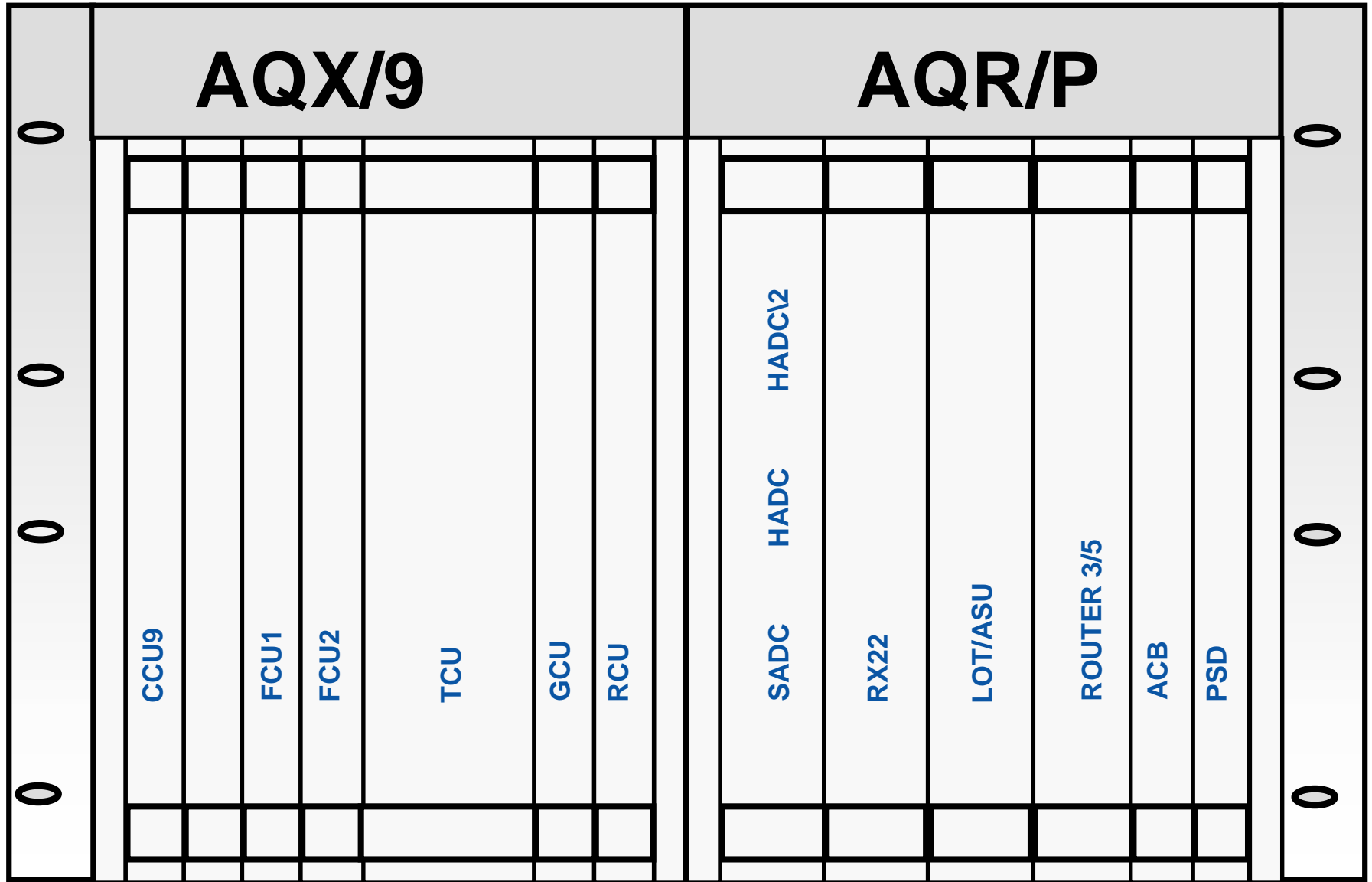

AVANCE TwoBay

General Description

ADDITIONAL MANUALS:

- AVANCE Service Manual
- Gradient Spectroscopy
- RF Gradient Spectroscopy
- GREAT 1
- SE 451
- B-HPCU
- High Power
- Power Router
- Power Filter
- Hardware Tests (HWT)
- Site Planning 300-700 MHz
- Site Planning 750-900 MHz

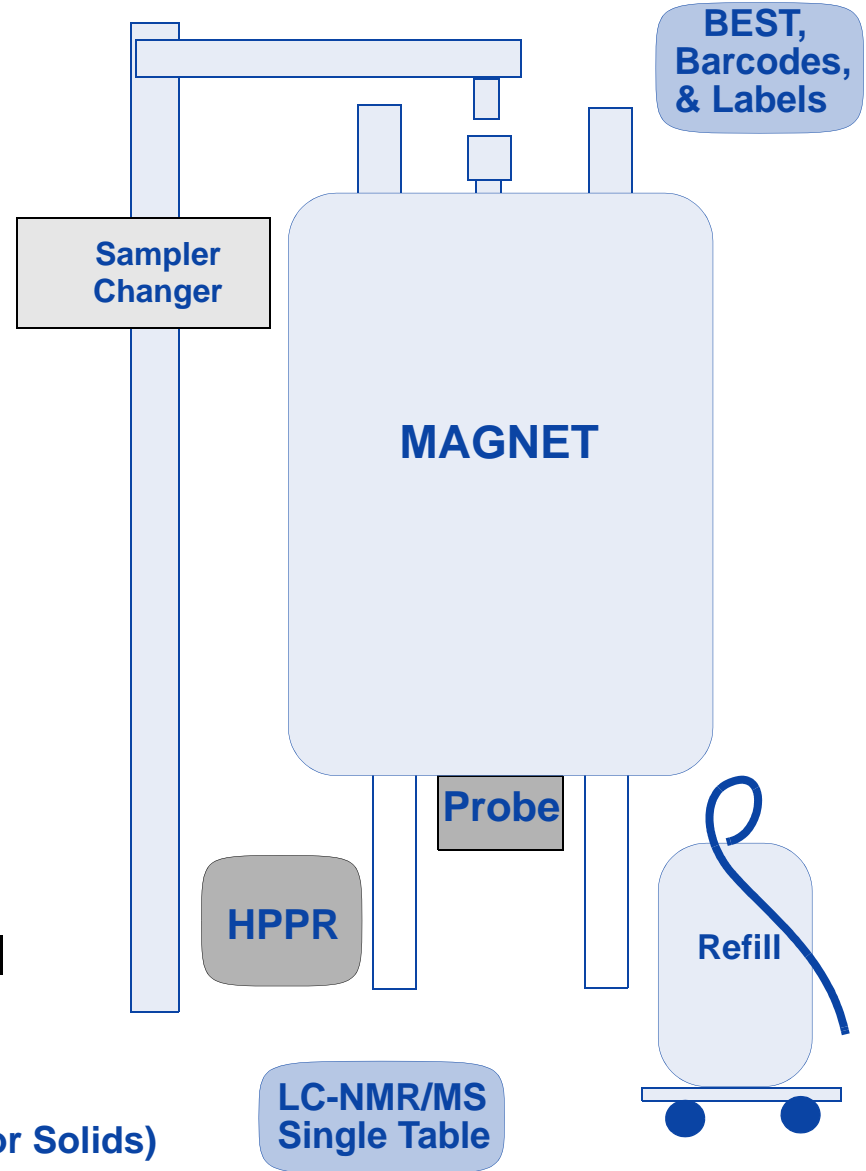
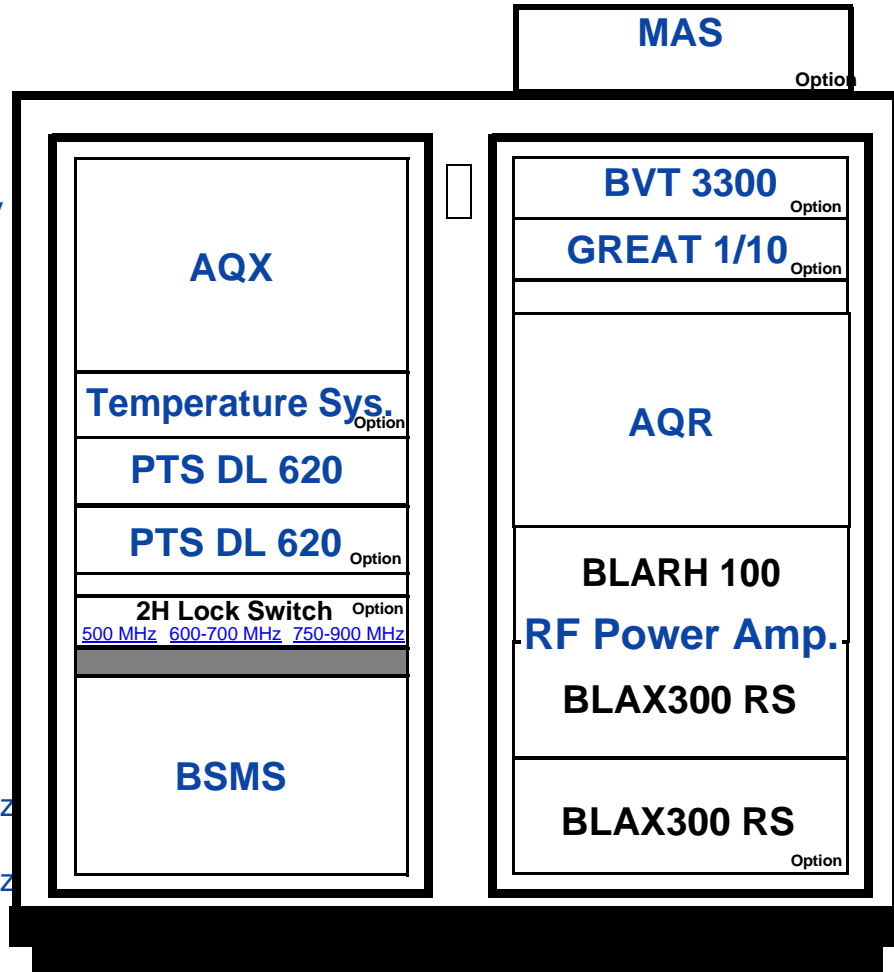

General Description (Optimized for Solids)

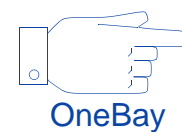
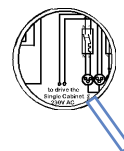
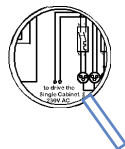

AVANCE TwoBay: AQX

ADDITIONAL
MANUALS:

[AQX Mainframe](#)

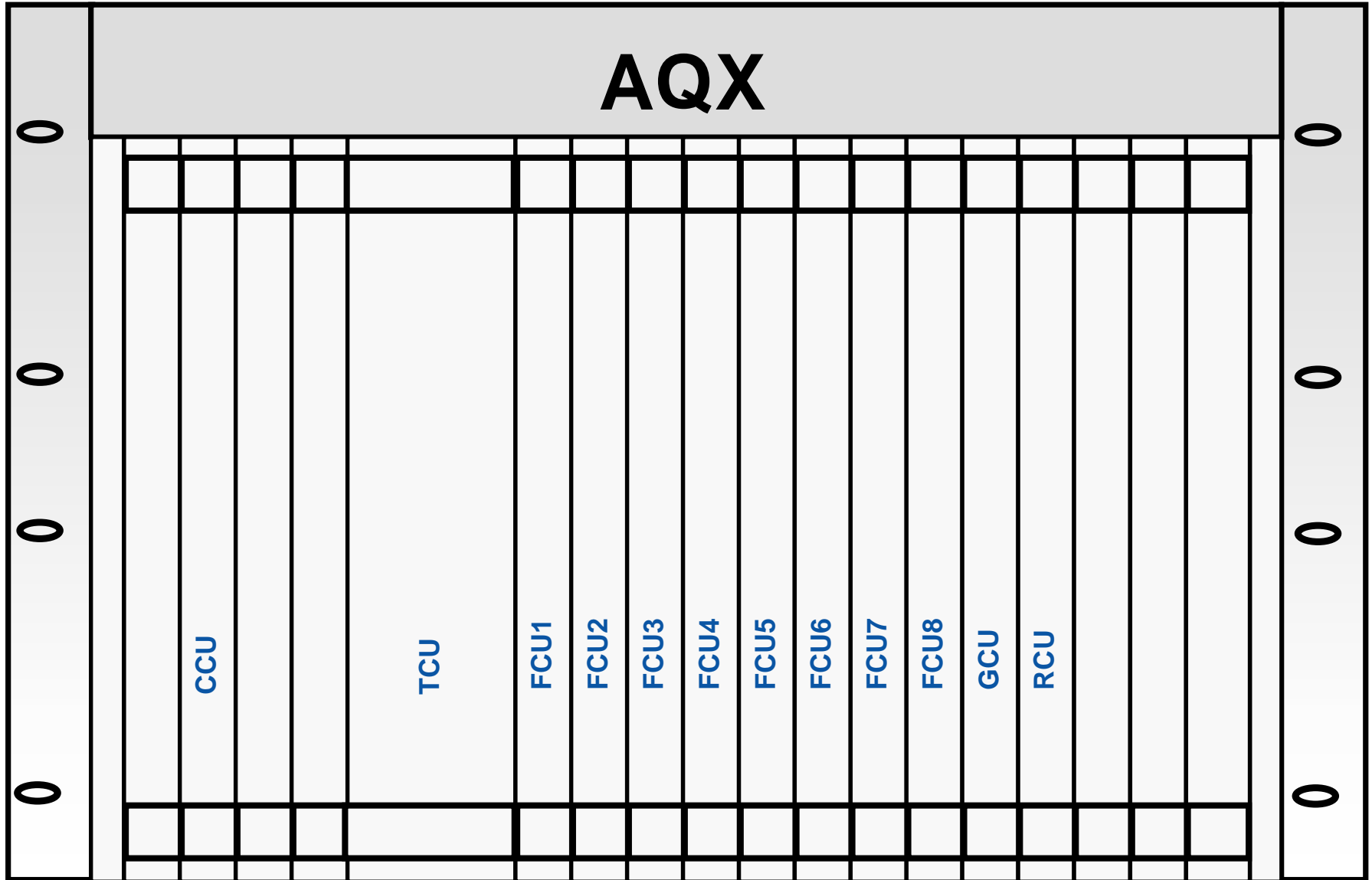

AVANCE TwoBay: AQR

ADDITIONAL MANUALS:

AQR Mainframe

4-Phase Modulator

ASU 1

ASU 2

FTLP/4M

RXC

RDCU

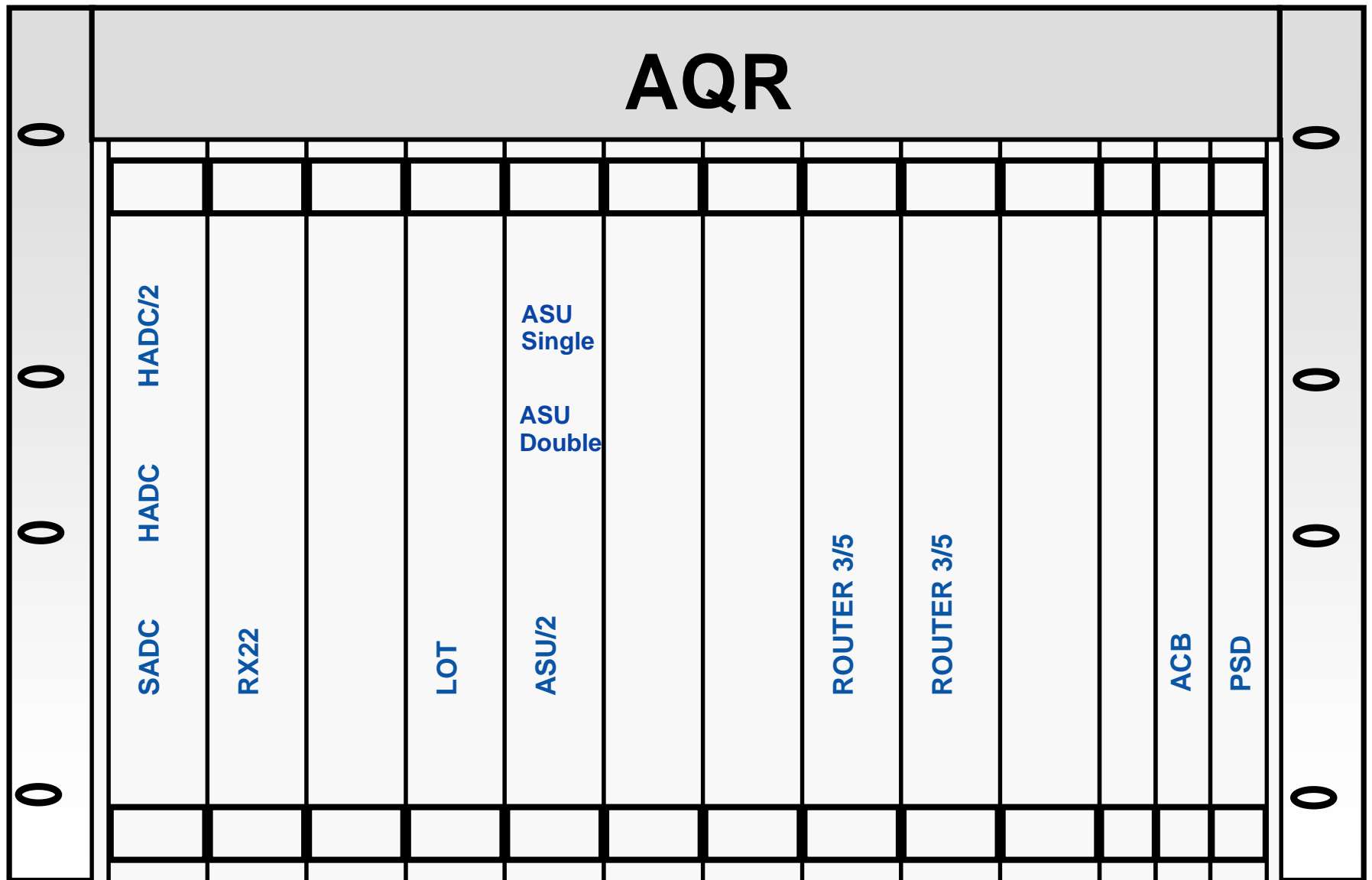

AVANCE: BSMS

ADDITIONAL
MANUALS:

BSMS Mainframe

BSMS User

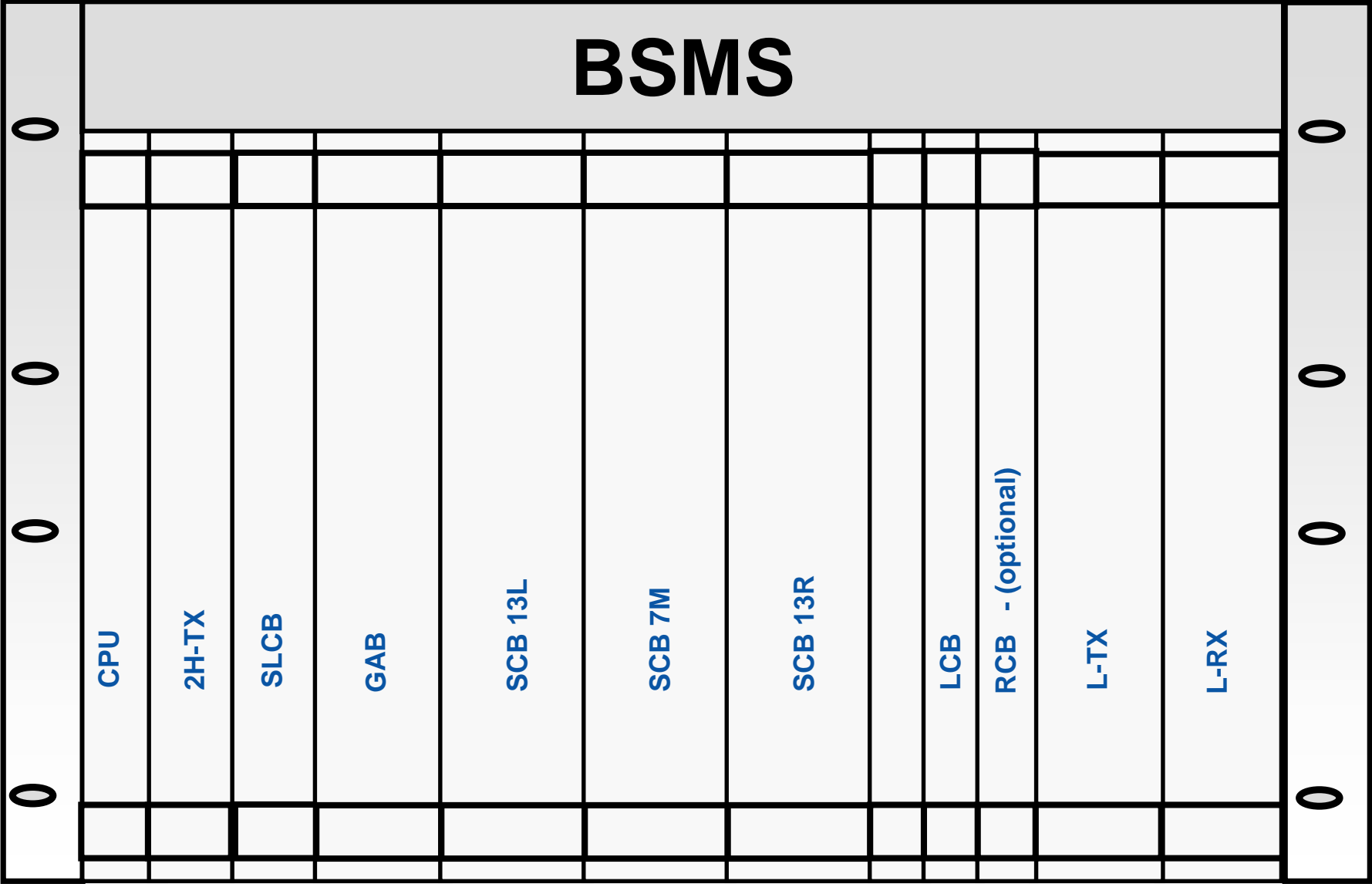

AVANCE AV with SGU - OneBay & MicroBay

General Description

ADDITIONAL MANUALS:

AVANCE AV Service Manual

Temperature Systems

Gradient Spectroscopy

RF Gradient Spectroscopy

GREAT 1

2H Lockswitch

Hardware Tests (HWT)

Site Planning 300-700 MHz

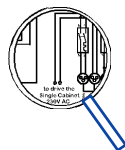
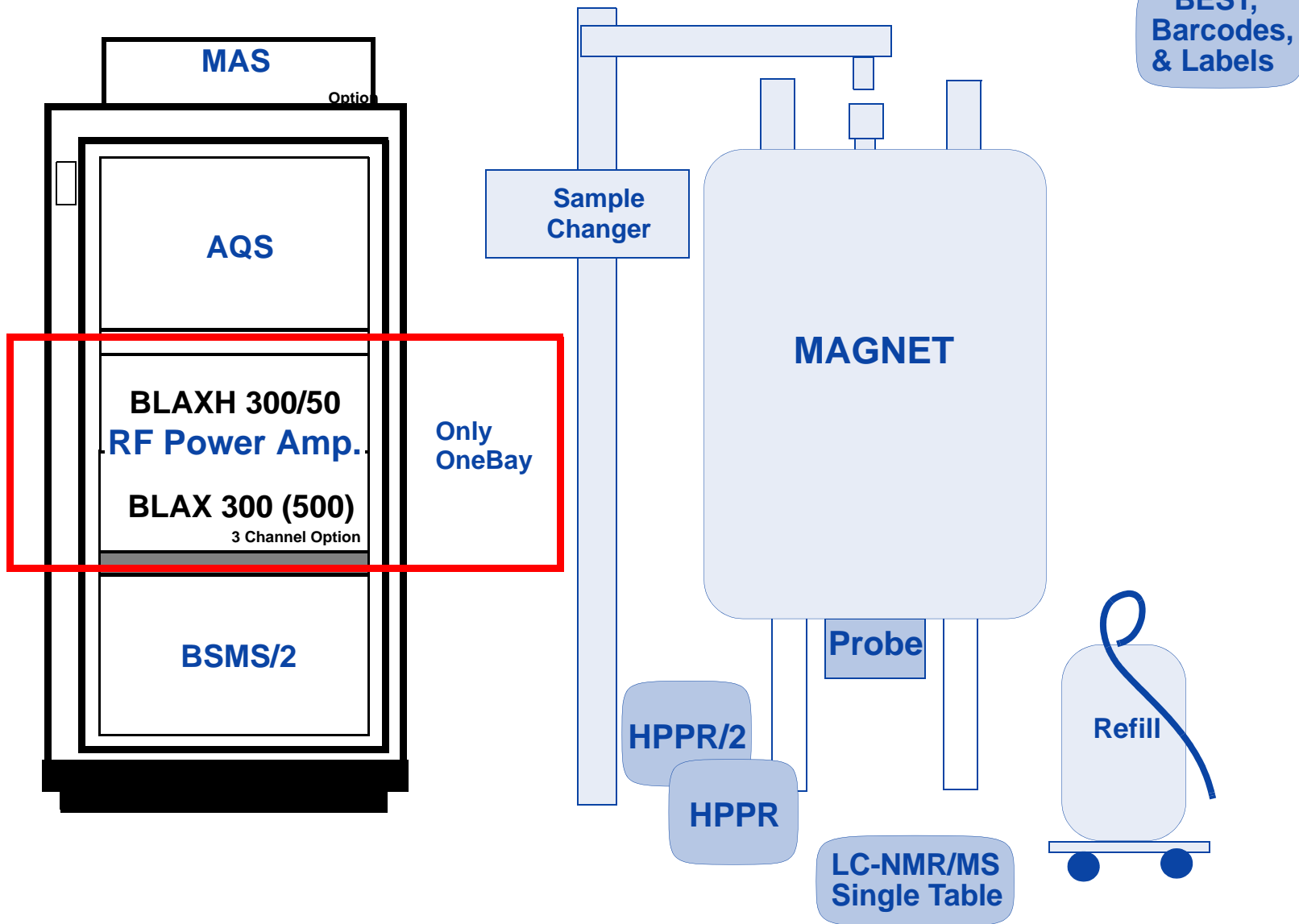

**CONSOLE
WIRING**

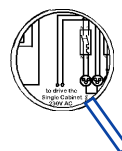

**BLOCK
DIAGRAM**

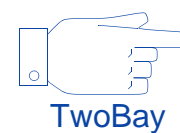

AVANCE AV with SGU OneBay: AQS

ADDITIONAL
MANUALS:

FTLP/4M

PSD

Router

ACB-Standard

ACB-Extended

AQS Technical

VME Backplane
8-slot

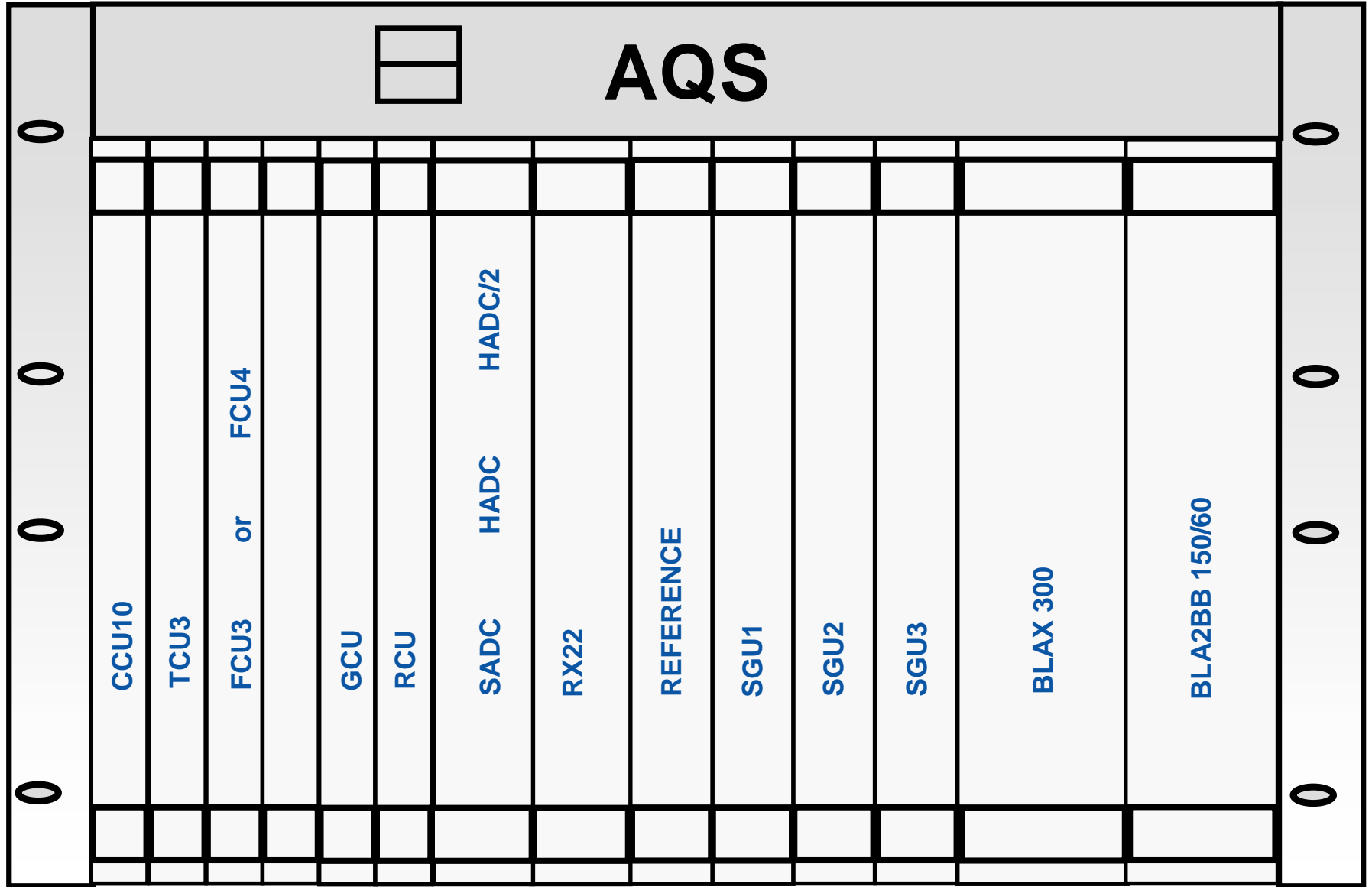

AVANCE AV with SGU TwoBay

General Description

ADDITIONAL MANUALS:

- AVANCE AV Service Manual
- Temperature Systems
- Gradient Spectroscopy
- RF Gradient Spectroscopy
- GREAT 1
- Hardware Tests (HWT)
- Site Planning 300-700 MHz
- Site Planning 750-900 MHz (Introduction)

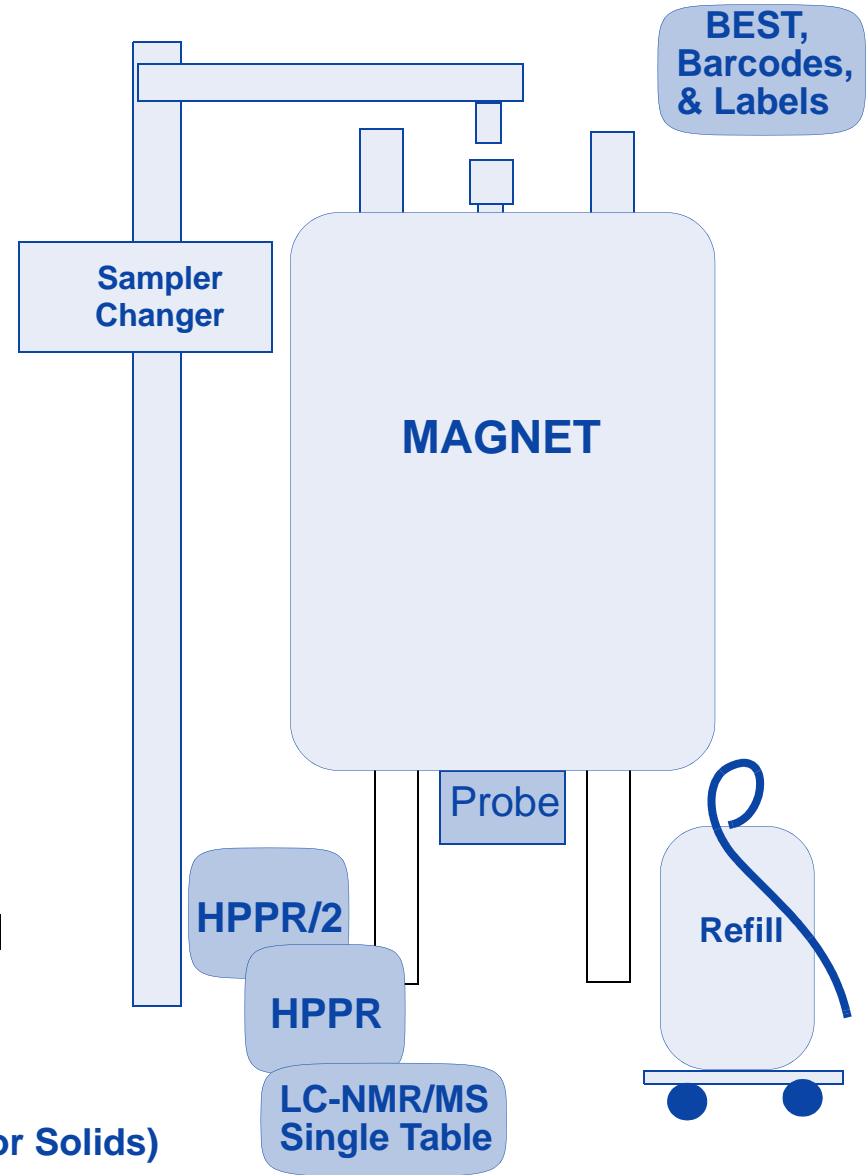
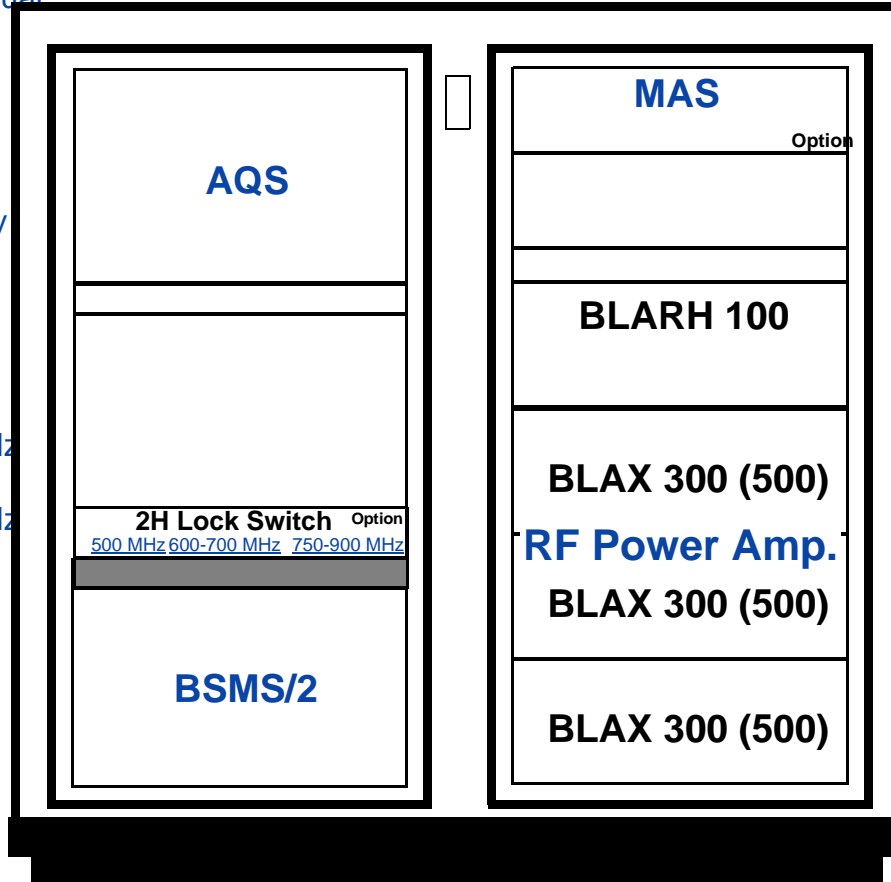

General Description (Optimized for Solids)

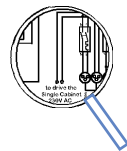

CONSOLE
WIRING

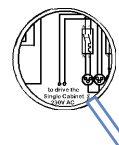

BLOCK
DIAGRAM



AVANCE AV with SGU TwoBay: AQS

**ADDITIONAL
MANUALS:**

FTLP/4M

PSD

ACB-Standard

ACB-Extended

AQS Technical

VME Backplane
8-slot

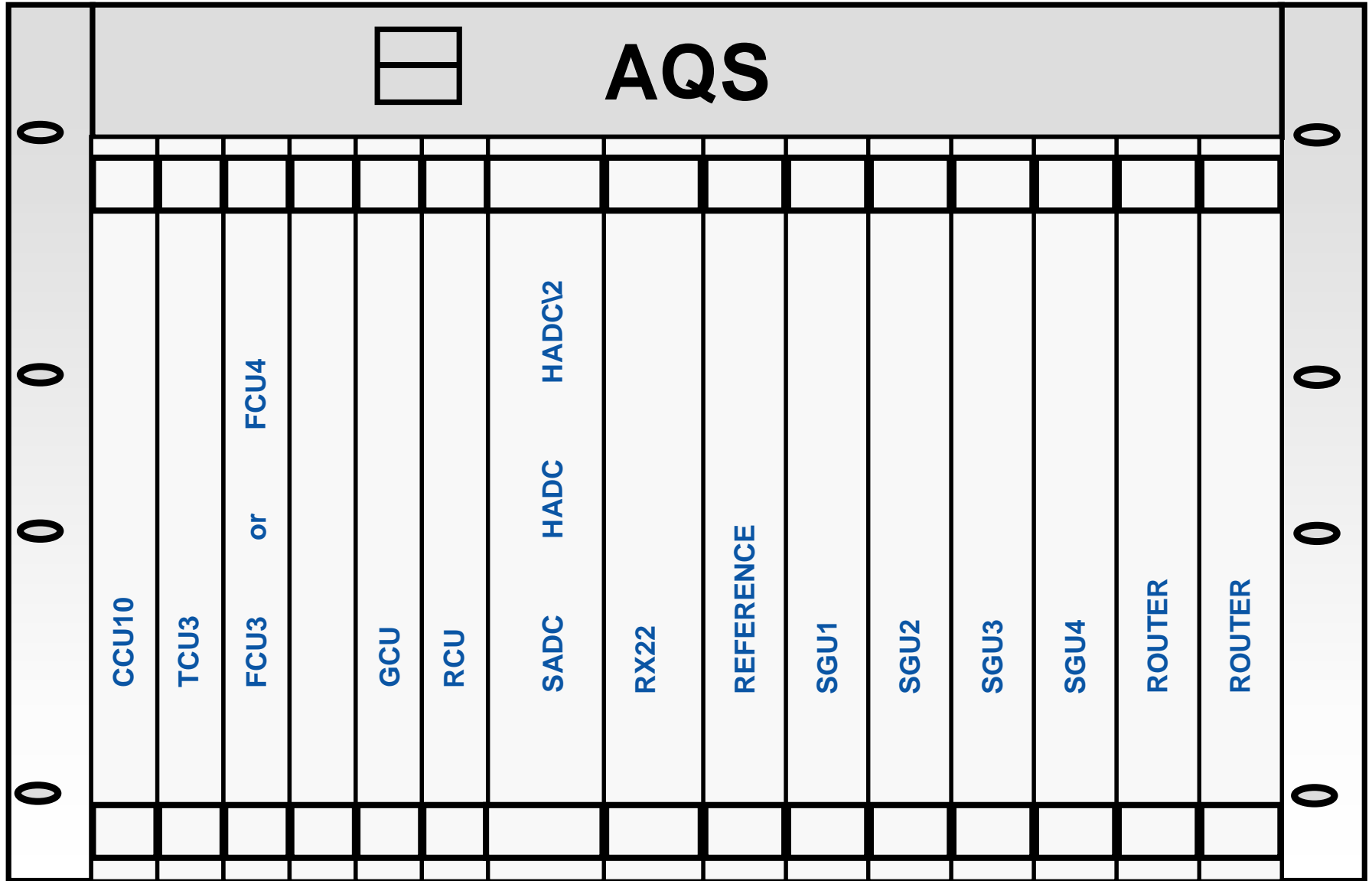

AVANCE AV with SGU: BSMS/2

ADDITIONAL
MANUALS:

BSMS/2 Mainframe

BSMS User

Pneumatic Module

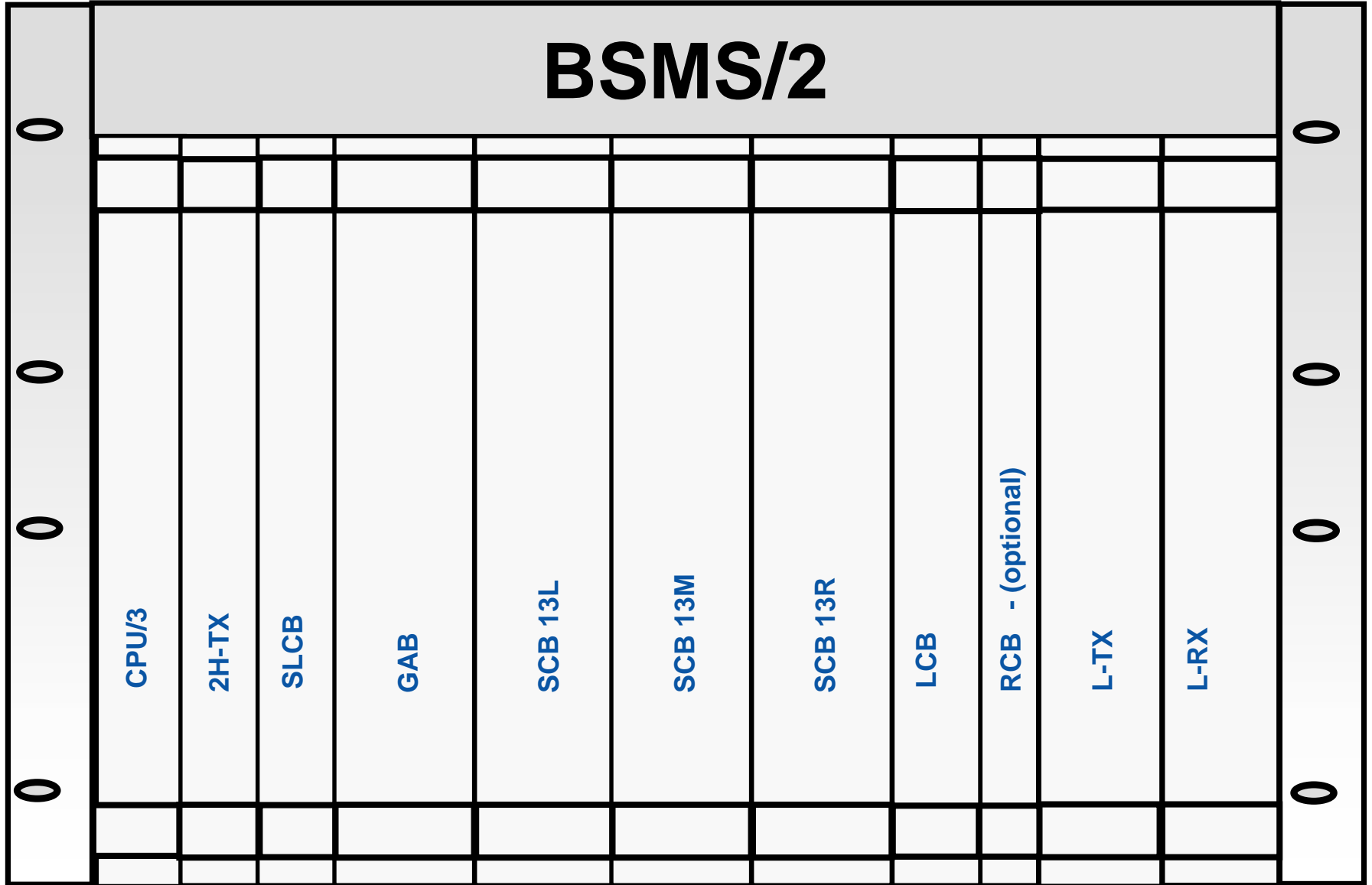

Magnet System



Important Notes



Installation Procedures



UltraShield™ Magnet System



Safety Notes



Troubleshooting



Monitoring System



Refill User Manual



Refill User Manual



Refill User Manual

Site Planning 300-700 MHz

Site Planning 750-900 MHz (Introduction)

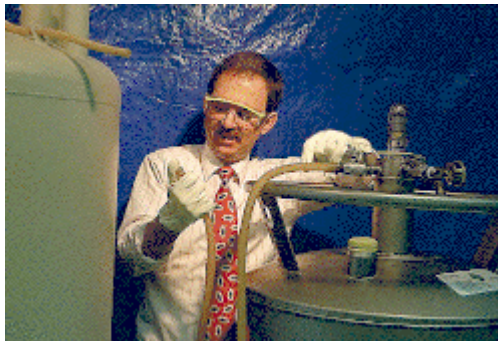

Refill User Manual



Refill User Manual



Nitrogen Fills (Movie)



Probes

CryoProbe System

Installation Manual

User Manual

Site Planning Guide

Rf Electronics Technical Manual

BTO2000

User Manual

Filter Configuration Version 1

Filter Configuration Version 2

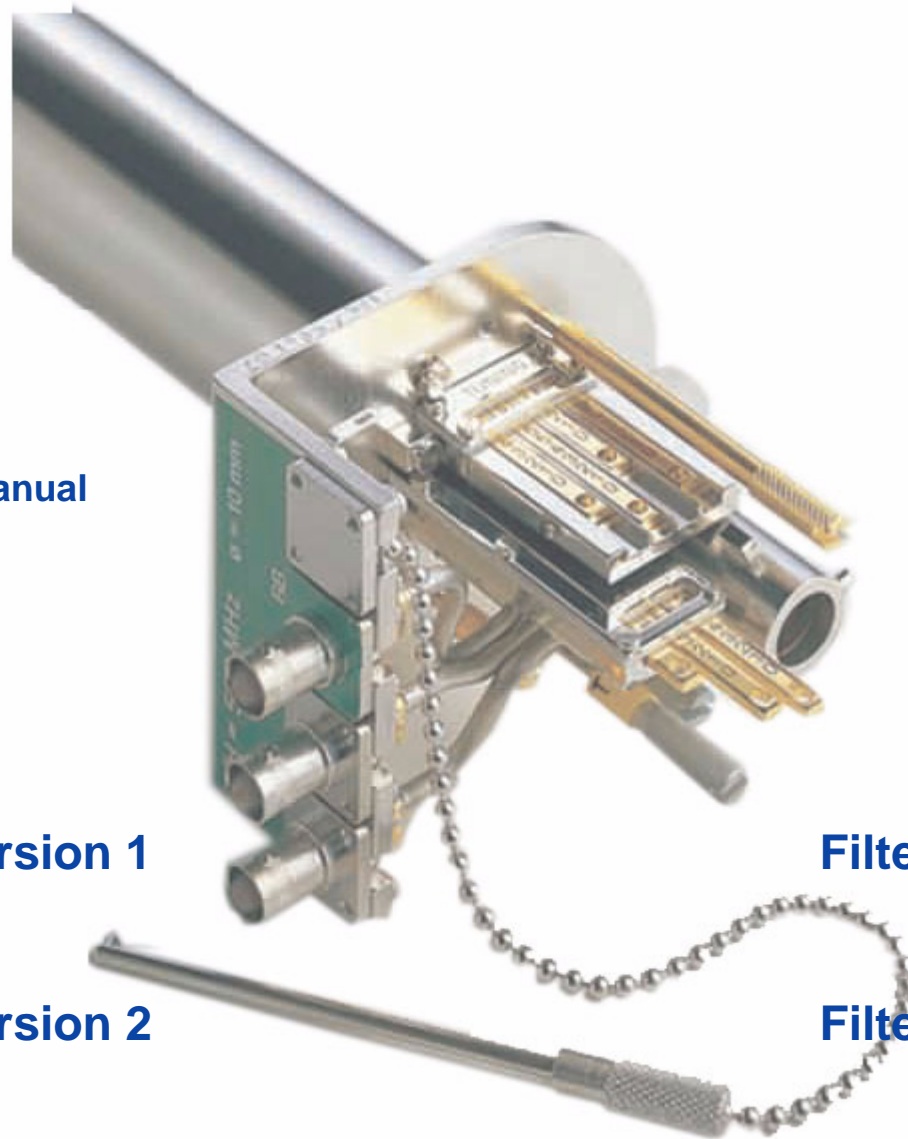

Probes

User Manual

HR-MAS

User Manual

Q-Switch

User Manual

ATM Accessories

User Manual

Filter Configuration Version 3

Filter Configuration Version 4



Temperature System

BCU05

Technical Manual

BVT3200

Technical Manual

BVTE3900

Technical Manual

BASM*

Technical Manual

BCU20 Cooling Device

Technical Specifications

BVT3300

Technical Manual

BMCM*

User Manual

VTU

User Manual

BVT3000

Technical Manual

BVTB3500

Technical Manual

Edte

User Manual



*Notes: BASM = Bruker Auxiliary Sensor Module (for BVT3000)
BMCM= Bruker Manual Control Module (for VTU)



Linear RF Power Amplifiers

BLARH100 200-400 MHz

Technical Manual

BLARH100 500-600 MHz

Technical Manual

BLARH100 900 MHz

User Manual

BLAX300 RS

Technical Manual

BLA2X500, BLAX500 & BLAX300 6-365 MHz

User Manual

BLAX1000 6-365 MHz

Operating/Service Manual

BLAX1000 30-325 MHz

Technical Manual

BLAX2500 RF Power Amplifiers

Operating/Service Manual

RF Amplifier EDACB Software

User Manual

BLAXH100/50 200-400 MHz

Technical Manual

BLAXH100/50 P 200-400 MHz

Technical Manual

BLAXH100/50 P 200-400 MHz

User Manual

BLAXH300/50 500-600 MHz

Technical Manual

BLAXH300/100 200-600 MHz

Operator/Service Manual

BLAXH500/100 700-900 MHz

Operator/Service Manual

BLAH 100 200-600 MHz

Operator/Service Manual

BLAH 100 700-900 MHz

Operator/Service Manual



Bruker Sample Changers

B-ACS 60/120
Instruction Manual



B-ACS 60/120
Installation Manual

NMR Case™
Installation Manual



NMR Case™
System Requirements

NMR Case™
Installation Manual



BEST, Barcodes, & Labels

BEST Barcode Reader
Installation Manual

**BEST NMR 215 Liquid
Handler**
Installation/User Manual

**BEST NMR 215 Liquid
Handler**
Upgrade Manual



Barcodes for Bruker Automation
User Information

Label Designer
Technical Manual

Bruker Barcode Standalone Unit
Instruction Manual

