

AVANCE Wiring

AVANCE 2 Bay Console User Manual

Version 005

BRUKER

The information in this manual may be altered without notice.

BRUKER accepts no responsibility for actions taken as a result of use of this manual. BRUKER accepts no liability for any mistakes contained in the manual, leading to coincidental damage, whether during installation or operation of the instrument. Unauthorised reproduction of manual contents, without written permission from the publishers, or translation into another language, either in full or in part, is forbidden.

This manual was written by

Francis Durrheimer

Desktop Published by

Stephane Kreiss

© September 30, 1997: Bruker Analytik GmbH

Rheinstetten, Germany

P/N: Z31228
DWG-Nr: 899005

Contents

	Contents	iii
1	Safety Considerations	5
1.1	CE Safety Information	5
1.2	Power Requirements	5
1.3	Important Safety Considerations	6
1.4	Switching the Console ON/OFF	7
1.5	Location of the Console Type Shield	7
1.6	Bruker Contact	10
2	Declaration of Conformity	11
3	Electrical Power Requirements	13
3.1	Introduction	13
	CP MAS	14
3.2	Voltage stabilisers	14
3.3	UPS	15
4	Console Configuration	17
5	Internal Wiring	21
6	Main Power Wiring.....	37
	Figures	41
	Tables	43

Safety Considerations

1

CE Safety Information

1.1

The Spectrometers that are referred to in the Declaration's of Conformity consist of the following components:

- Two Bay Console (refer to figure 4.1 for inside components)
- HPPR (preamplifier)
- BSMS Keyboard
- Shim System and Probehead

These Declaration's of Conformity do **not** refer to the following components:

- Magnet
- NMR Station (Silicon Graphics) with their peripherals.
- If present: Temperature Unit (when in it's own case)
- GREAT Unit (when in it's own case)
- MAS Unit
- Sample Changer

Power Requirements

1.2

The console can be used with a single phase or triple phase mains supply.

Please refer to the Site Planning Manual for further information.

Details of the wiring for the mains supply can be found in figures 4.2 and 6.1 of this manual.

 **THE CONNECTION OF THE TWO BAY CONSOLE TO THE MAINS POWER SUPPLY MUST BE CARRIED OUT BY SPECIALLY TRAINED TECHNICIANS!!!**

⇒ ***ONLY TRAINED PERSONNEL SHOULD POWER AND OPERATE THE INSTRUMENT!!!***

Standard Operation

For standard operation of the console, the console doors and the rear panel must be closed to prevent Electromagnetic Interference.

Removing the Rear Panel

To remove the rear panel, loosen the two quick-release screws.

Disconnect the cable to the fan (inside).

⇒ ***Caution: Beware - the fan in the rear panel is still running!!!***

⇒ ***Caution: Hold onto the rear panel tightly to prevent it from falling over, or on your feet!!!***

Switching the Console ON/OFF**1.4**

Figure 1.1. Location of the ON/OFF Switch for the Console

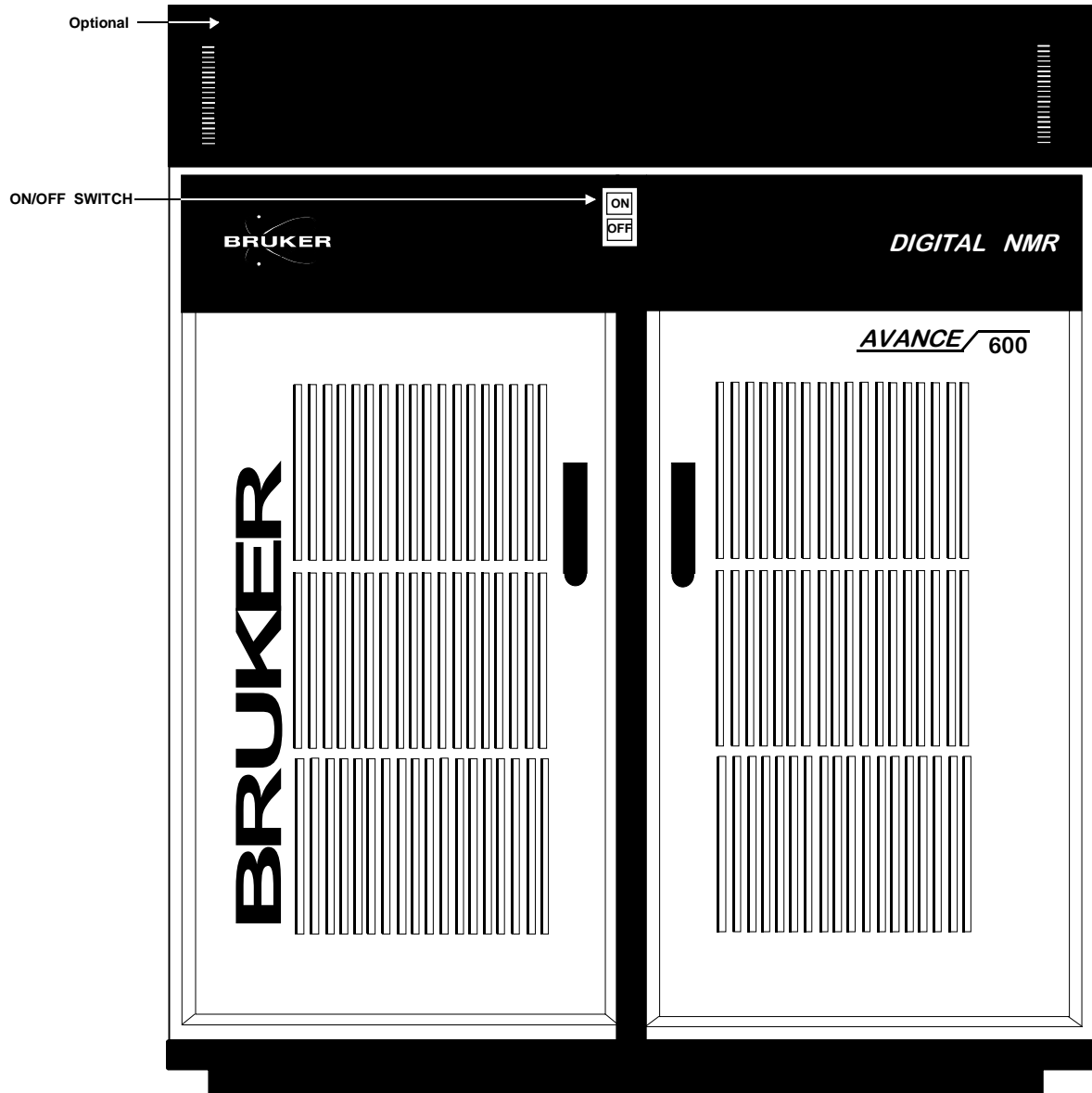

KST 30.09.97 FRONAVAN.DS4

Location of the Console Type Shield**1.5**

The shield showing the console type, is located inside the console on the top right front corner as you look into the console with the doors open (see the figure below).

Safety Considerations

Figure 1.2. Location of Console Type Shield

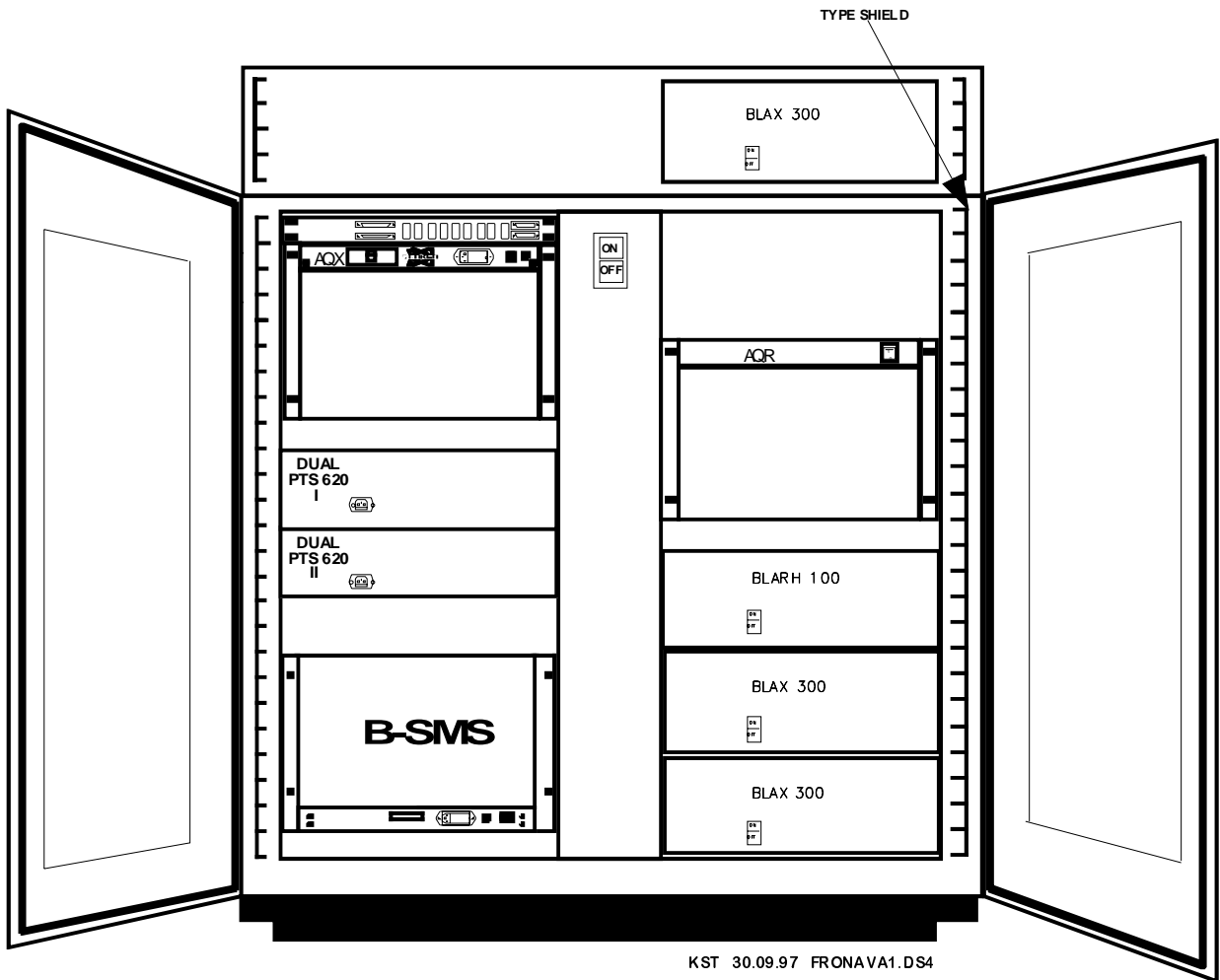
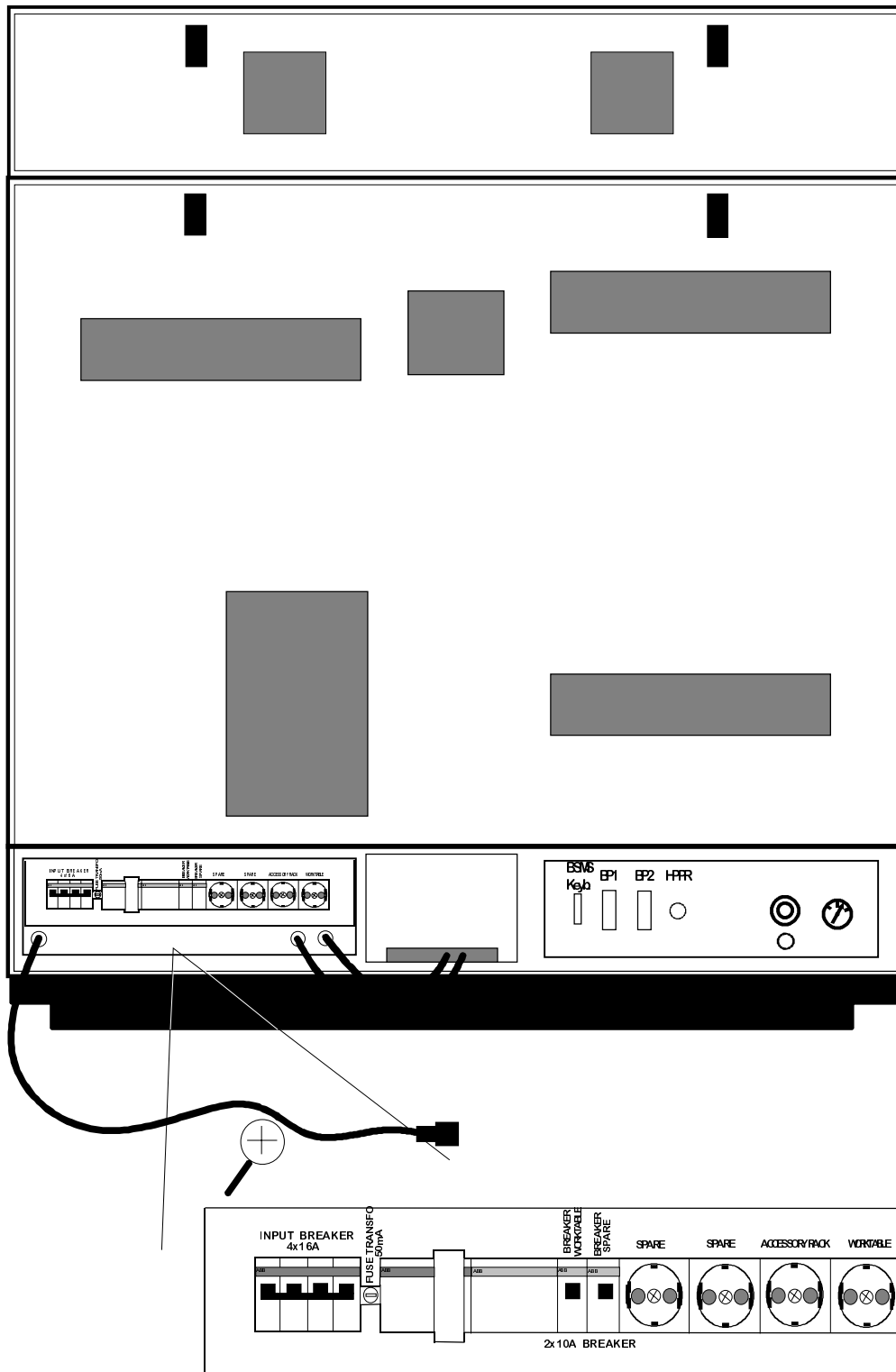

Figure 1.3. Location of the Fuses in the Console



BLOC PROTECTION 230V

KST 30.09.97 REARAVAN.DS4

➡ ***IF YOU SHOULD EXPERIENCE ANY PROBLEMS WITH THE CONSOLE, YOU MUST CALL YOUR NEAREST BRUKER SERVICE REPRESENTATIVE. DO NOT TRY TO FIX THE PROBLEM YOURSELF!!!***

Declaration of Conformity

2



DECLARATION OF CONFORMITY

The undermentioned product

**NMR Spectrometer AVANCE 2 Bay Console
H05130 & H04129**

conforms to the main requirements
set by the commission for the
Harmonization of Regulations of the EU Member States
with regards to electromagnetic compatibility
(EMI 89/336/EWG) and safety (Low Voltage Electrical
Equipment: 72/23/EWG) regulations.

For the assessment the following norms were applied:

EMI: EN 55 011; EN 50 082-1

Safety: EN 61 010-1

Test report UNI KA 9445 & 9419
Documentation: Z35081 Docu Standard: AVANCE

Manufacturer's Name: Bruker Elektronik D-76287 Rheinstetten
SADIS F-67166 Wissembourg
SAG CH-8117 Fällanden

Declaration approved by:

Dr. Tonio Gianotti
Head of Development

Victor Ringeisen
Technical Manager

Werner Schittenhelm
Direction

September 1, 1997

Electrical Power Requirements

3

Introduction

3.1

The power supply for the 750 MHz system is controlled exclusively by the BMPC (Bruker Magnet Pump Control) unit. This unit is described separately in the manual entitled "Introduction to site planning for a 750MHz system".

Table 3.1 lists the power requirements and power consumption of various AVANCE systems. The power consumption quoted, includes the NMR station and graphics monitor and was measured using 2 amplifiers operating at maximum output in cw mode while using the printer plotter. This represents effectively the maximum power consumption possible for a standard AVANCE system. For systems fitted with additional amplifiers allow 300W for each additional amplifier.

A fuse or circuit breaker, 16A slow-blow must be installed on the mains supply (230V/50/60Hz single phase).

When planning the electrical power requirements of your site make provision for extra equipment which you may install e.g. Personal Computers, work stations air conditioning systems, etc.

Table 3.1. Power Requirements of Basic System (2 Channels)

System and Amplifiers	Mains Supply	Power Consumption (kW)	No. of Spare Electrical Outlets	Length of Mains Cable
Avance 2 bay with SE451 BLARH100 + BLAX300	230V 50/60 Hz / 16 A single phase or 230V/400V 50/60 Hz / 10 A triple phase	2.6	2	5,5m
Avance 2 bay with solide acc. BLAX1000 + BLAH1000	230V 50/60 / 16A triple phase	5,0	2	5,5 m
Avance 2 bay BLAXH50/100	230V 50/60 Hz / 16 A single phase	2.2	2	5.5 m
Imaging Cabinet	230 V / 50/60 Hz / 16 A single phase Power from AVANCE supply	2.1		

Electrical Power Requirements

Each AVANCE cabinet comes supplied with four electrical outlets (230V/10A) which can be used to power standard ancillary equipment. Two outlets are designed for the work table (i.e NMR Station) and (optional) accessory cabinet. The other two outlets are then free. Table 3.2 lists the standard equipment and corresponding power source.

The NMR Station and accessory cabinet units should be powered directly from the AVANCE cabinet as this minimises grounding problems which might otherwise lead to artifacts. "Optional" means that the unit may be powered either from the AVANCE cabinet or from a separate supply. Table 3.3 lists the power requirements of other equipment which, because of their large power consumption, require power sources separate to that of the AVANCE cabinet.

Table 3.2. Console Powered Units

Unit	Power Source
NMR Station/Graphics Monitor	AVANCE Cabinet
Micro Imaging Cabinet	AVANCE Cabinet
Printer Plotter	Optional
Automatic Sample Changer	Optional

Table 3.3. Units That Require Separate Power Units

Unit	Mains Supply	Maximum Power Consumption
BCU 05	230V / 50/60 Hz / 16 A single phase	0.45 KW

CP MAS

3.1.1

The power requirements of this unit will depend on the amplifiers that are used. The control unit itself will not use more than 100W.

Voltage stabilisers

3.2

If line voltage fluctuations exceed -10% to +5% a voltage stabiliser must be used. Even if the fluctuations are well within these limits, the purchase of a line conditioner may prove to be a good investment. The lifetime of the various electrical components in the spectrometer will be lengthened when the supply is stabilised. When deciding on a stabiliser you should take note of the following:

1. Power Requirement: The stabiliser must be capable of delivering the total power requirements of the various units you wish to protect. A surplus capacity of at least 10% is recommended.
2. Remember to take consideration of future equipment that you may decide to install.

3. The stabiliser must of course be compatible with the input voltage, number of phases and A.C. frequency. Typically the stabilisers can cope with input fluctuations of 20%.
4. Output: The NMR units described in this manual normally use 230V/50-60Hz/ single phase with the exception of the High Power Cabinet which uses 400V/ 50-60Hz/triple phase.
5. The regulation accuracy of the output need be no greater than 1% for single phase and 2% for three phase.
6. Single phase stabilisers use saturated transformers to regulate the voltage and should have fast response times, typically 10-20 msec. Three phase stabilisers however use motors and have slower response times. A regulation speed of 15V/s is usually sufficient to overcome mains fluctuations in most countries.
7. Other considerations are lifetime, size, noise output and maintenance requirements.

 **Contact your local Bruker/Spectrospin office for advice on a voltage stabiliser suited to your particular system.**

If ordering a stabiliser you should specify:

Input voltages.

Number of phases.

Special requirements e.g. output connectors, meters, housing etc.

Details of units and accessories that require protection.

Where total interruption of supply occurs frequently, then the customer should consider installing a UPS (Uninterruptable Power Supply) linked to an automatic cut-in generator. This is particularly advisable when long-time experiments are to be run. While a total loss of power will not damage the spectrometer hardware, NMR data acquired immediately prior to a power cut and which has not been stored on the computer hard disk may be lost. The difference between UPS systems and a voltage stabiliser is that the UPS system contains a battery back-up pack which will maintain the power supply to the spectrometer for a limited period after a total loss of mains supply. Typically the battery back-up will last for up to 10 minutes at the rated power. This gives time for a generator to replace the mains power or for the spectrometer computer to be shut down according to the correct procedures. Additional battery packs which extend the back-up period to 30 minutes at the rated power are also available. As well as maintaining supply, the UPS system also serves as a line conditioner. Typical output voltages stability are 2% static and dynamic with frequency stability of 1%.

The current requirements of the UPS when recharging batteries (e.g. after a supply failure) is greater the normal. Typically a 7KWA UPS needs 45A during recharge and the supply must be able to cope with this size of current.

Contact your local Bruker/Spectrospin office for advice on a UPS system suited to your particular system.

Electrical Power Requirements

NOTE:

1. The power supply to the spectrometer should be "clean" i.e. it should not share with air conditioners etc.
2. All mains earths in the lab should be connected together to avoid differences in earth potential. This will avoid problems when, for example, a P.C. powered externally is connected to the spectrometer via a RS232 link.
3. Some customers fit RCCB (residual current circuit breakers) to the spectrometer supply. These are designed to switch off the supply if there is an imbalance in the current in the live and neutral lines. If these are fitted to an AVANCE series spectrometer then they should be rated at 100mA. The lower value of 30mA commonly used is too sensitive for these spectrometers.

Console Configuration

4

Figure 4.1. Avance 2 bay console Front View

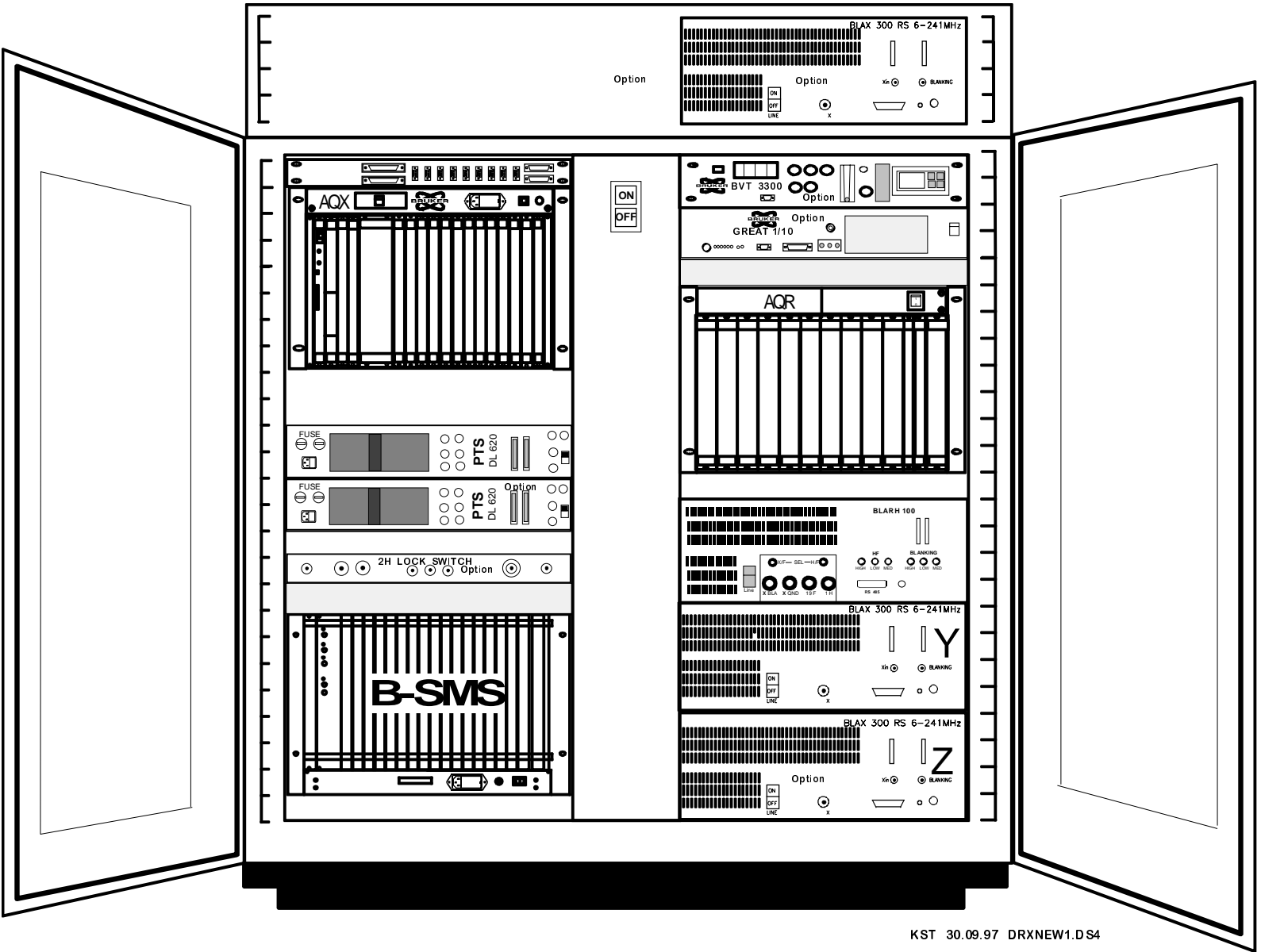

KST 30.09.97 DRXNEW1.DS4

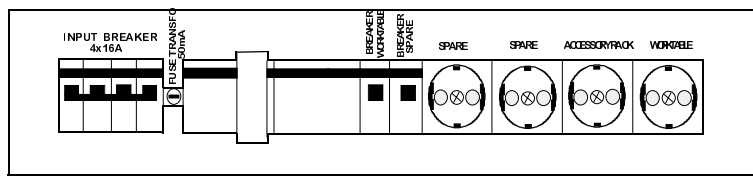
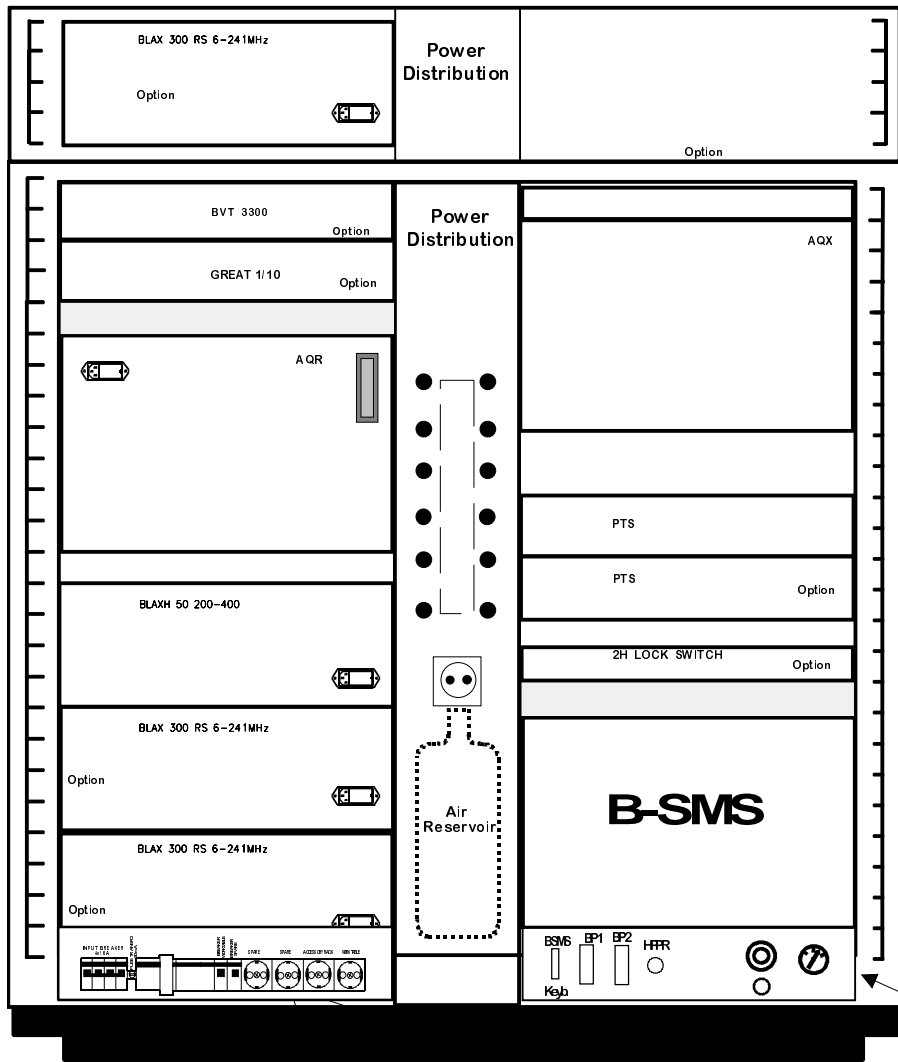

BLOC PROTECTION 230V

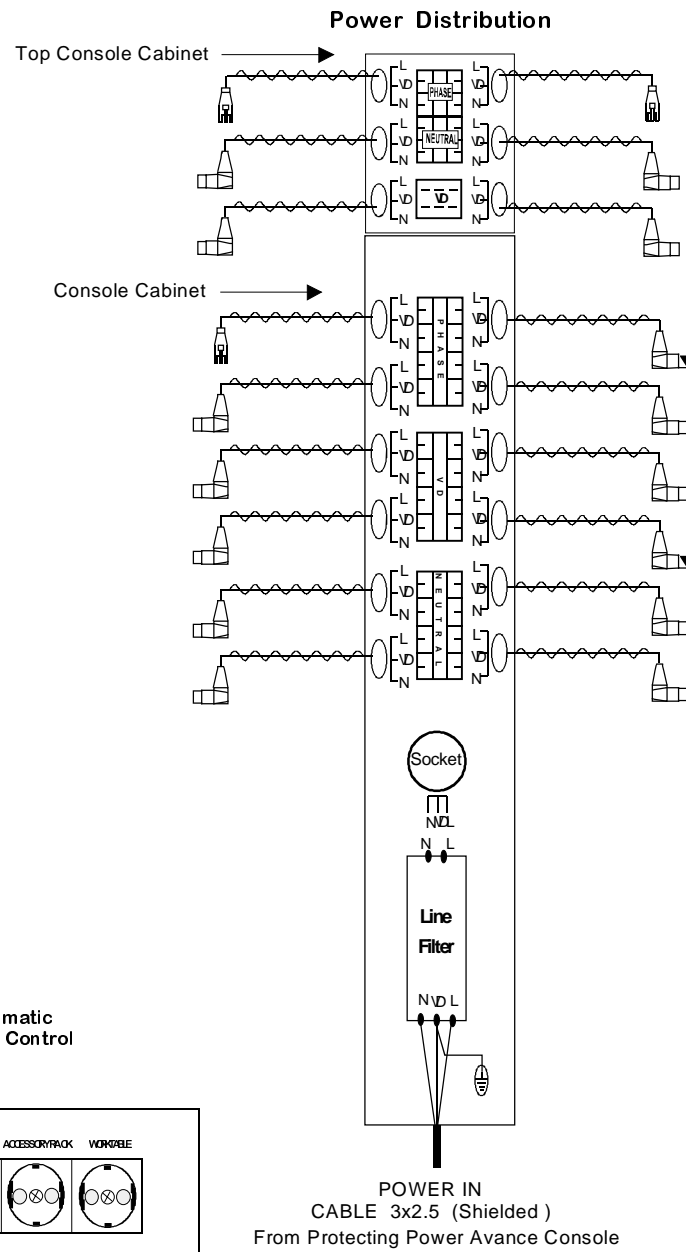

KST 30.09.97 DRXNEW2.DS4

Figure 4.2: Avance 2 bay console Rear View

Internal Wiring

5

Figure 5.1. Avance 2 bay RX22 DC Wiring Diagram Page 1

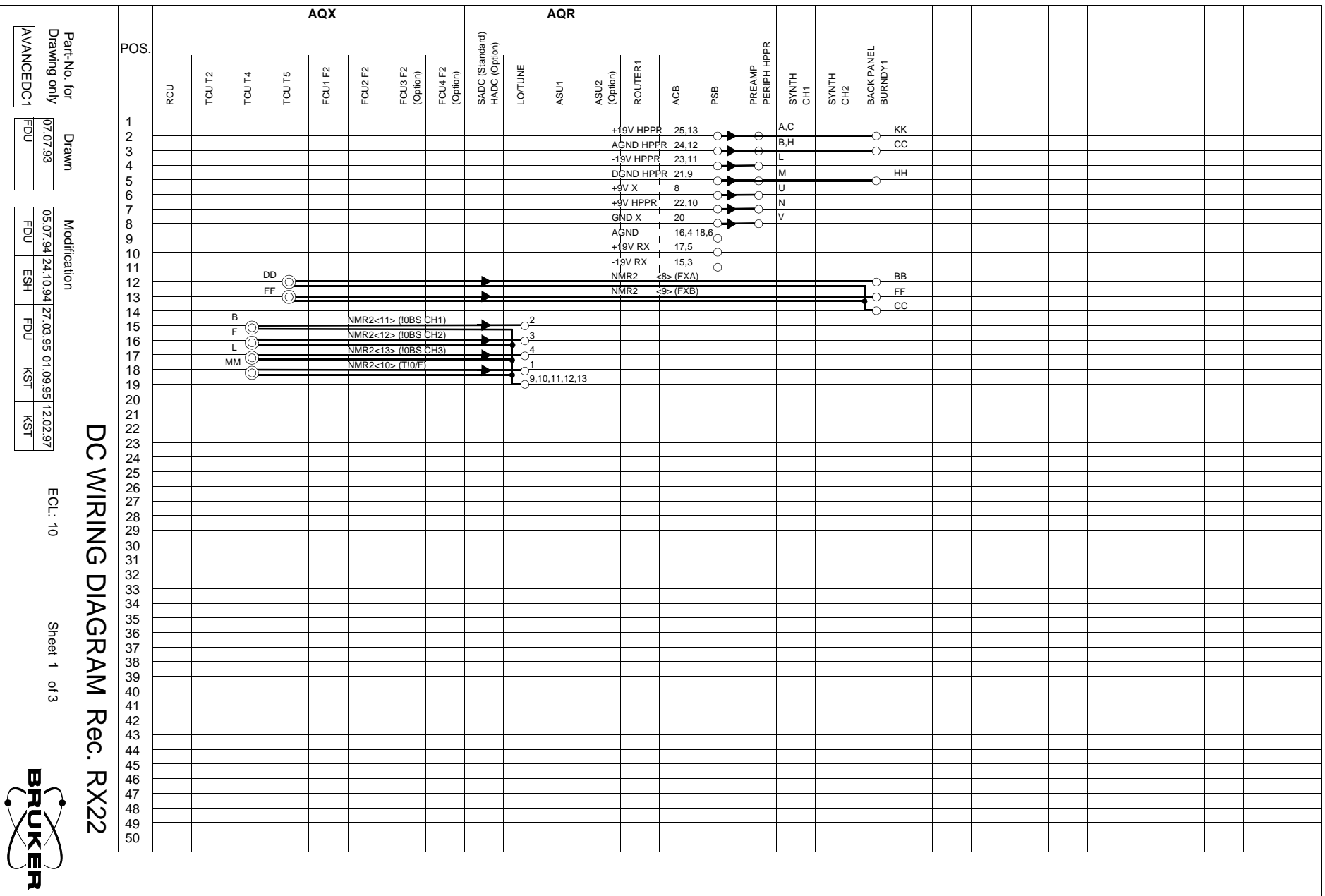

DC WIRING DIAGRAM Rec. RX22

Part-No. for Drawing only
 Drawing No. 07.07.93
 AVANCEDC1 FDU

Modification
 05.07.94 24.10.94 27.03.95 01.09.95 12.02.97
 FDU ESH FDU KST KST

ECL: 10

Sheet 1 of 3



Figure 5.2: Avance 2 bay RX22 DC Wiring Diagram Page 2

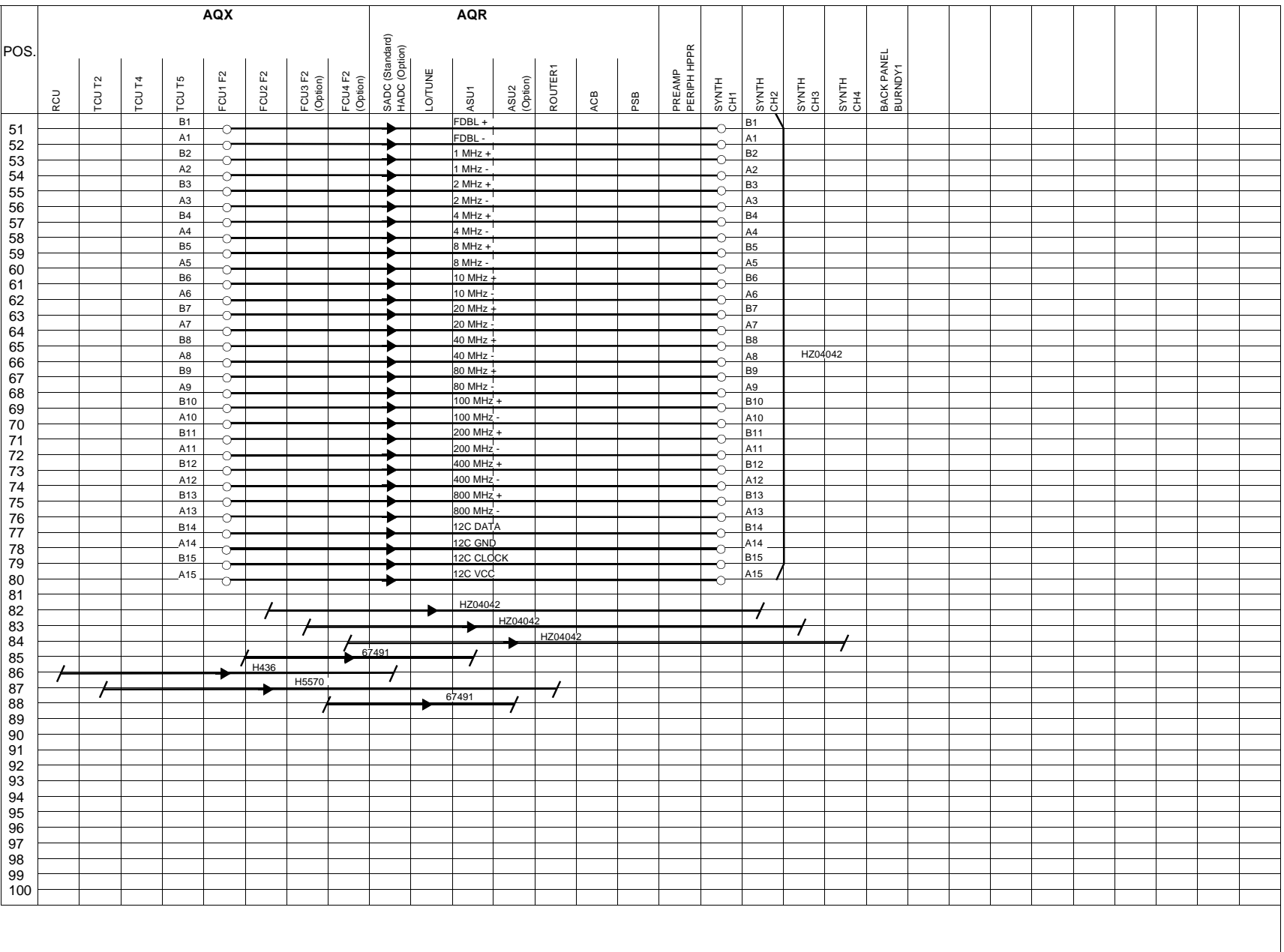

DC WIRING DIAGRAM Rec. RX22

Part-No. for Drawing only
AVANCEDC2

Drawn
07.07.93
FDU

Modification
05.07.94 24.10.94 27.03.95 01.09.95 12.02.97
FDU ESH FDU KST KST

ECL: 10

Sheet 2 of 3



Figure 5.4. Avance 2 bay RX22 HF Wiring Diagram Page 1

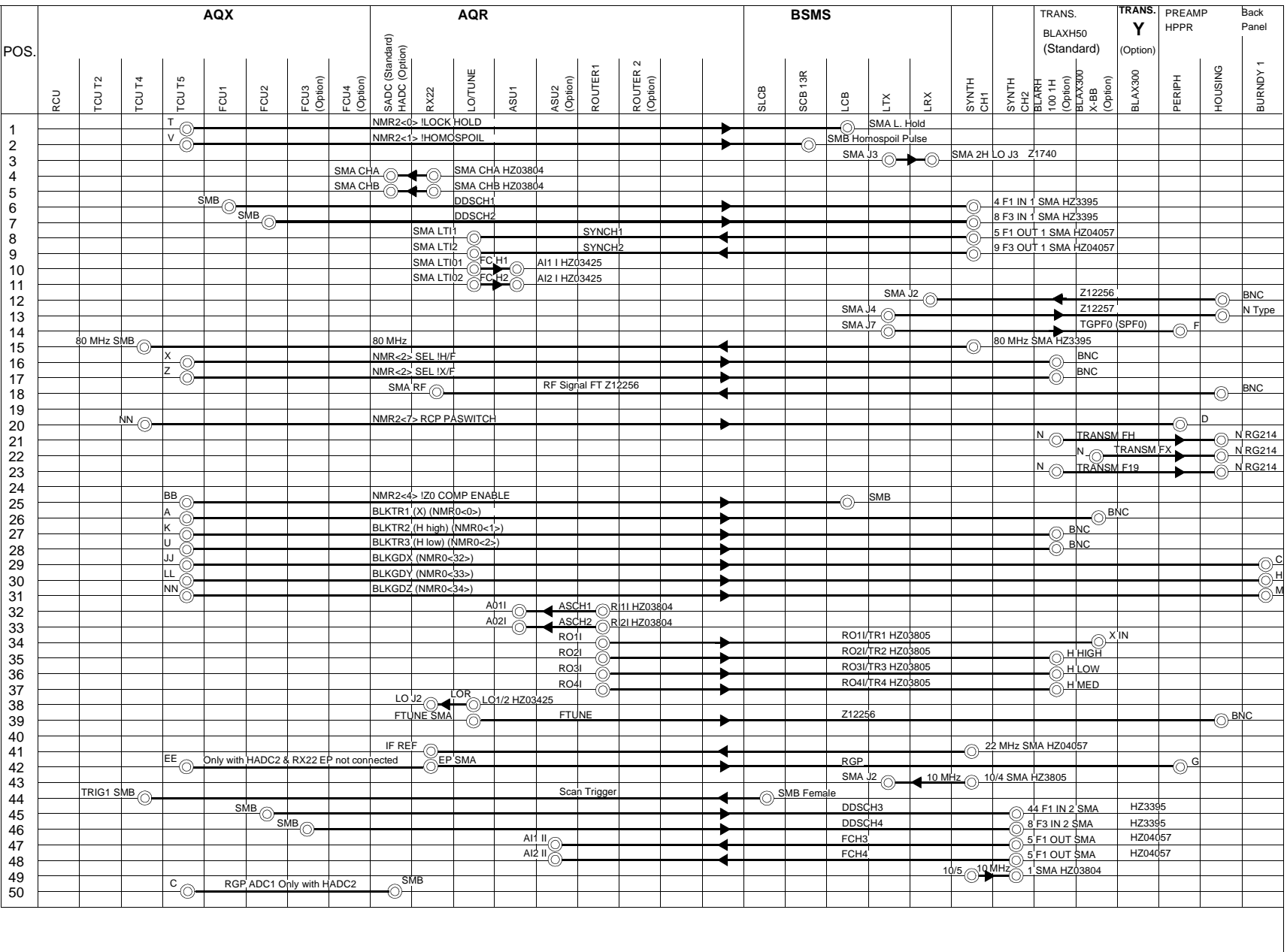

HF WIRING DIAGRAM Rec. RX22

Part-No. for Drawing only
 27.07.93
 AVANCE HF1

Drawn
 FDU
 Modification
 24.10.94 27.03.95 01.09.95 01.07.96 12.02.97
 ESH ESH KST KST KST

ECL: 10

Sheet 1 of 2



Figure 5.5. Avance 2 bay RX22 HF Wiring Diagram Page 2

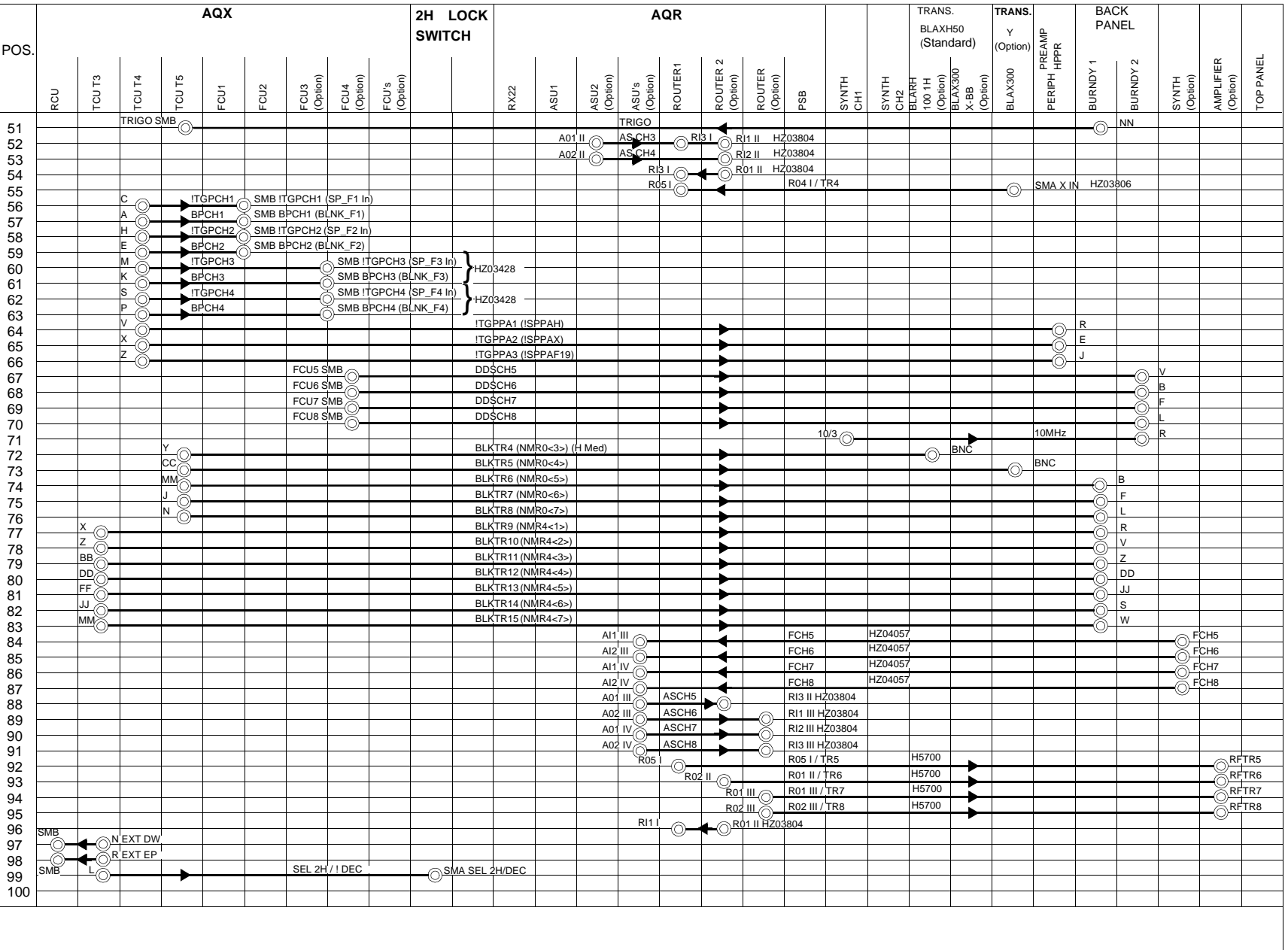

HF WIRING DIAGRAM Rec. RX22

Part-No. for Drawing only
AVANCEHF2

Drawn 27.07.93
Modification 26.09.94 24.10.94 27.03.95 01.09.95 12.02.97
FDU ESH FDU KST KST

ECL: 10

Sheet 2 of 2



Figure 5.6. Backpanel Burndy1 & Burndy2 (RX22)

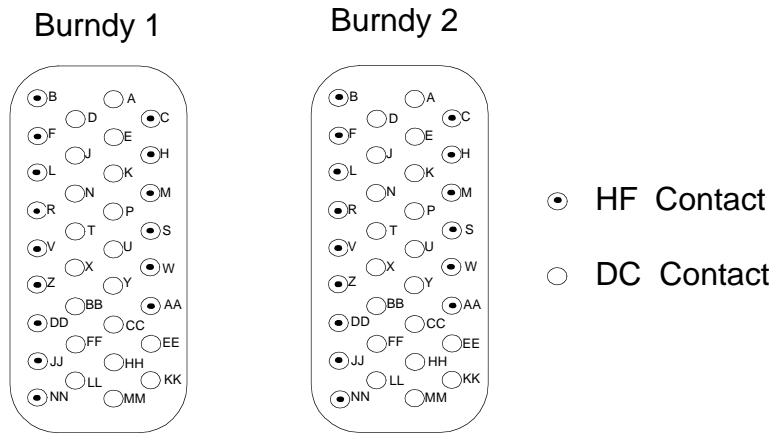

Table 5.1. Signal Name Burndy1 & Burndy2 (RX22)

COAX CONNECTIONS		
PIN	BURNDY 1	BURNDY 2
B	BLKTR6(NMR0<5>)	DDSCH6
F	BLKTR7(NMR0<6>)	DDSCH7
L	BLKTR8(NMR0<7>)	DDSCH8
R	BLKTR9(NMR4<1>)	10MHz
V	BLKTR10(NMR4<2>)	DDSCH5
Z	BLKTR11(NMR4<3>)	
DD	BLKTR12(NMR4<4>)	
JJ	BLKTR13(NMR4<5>)	
NN	TRIG0	
C	BLKGDY(MNR0<32>)	
H	BLKGDY(NMR0<33>)	
M	BLKGDZ(NMR0<34>)	
S	BLKTR14(NMR4<6>)	
W	BLKTR15(NMR4<7>)	
AA	MIXCC(option)	

DC CONNECTIONS		
PIN	BURNDY 1	BURNDY 2
D		
J		
N		
T		
X		
BB	NMR2<8>(FXA)	
FF	NMR2<9>(FXB)	
LL		
A		
E		
K		
P		
U		
Y		
CC	AGND HPPR	
HH	DGND HPPR	
MM		
EE		
KK	+19V HPPR	

Internal Wiring

Figure 5.7. Backpanel Periph. HPPR (RX22)

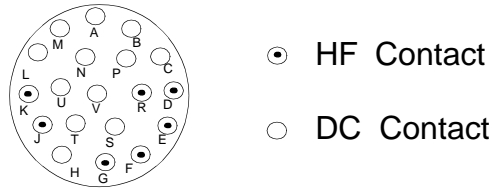
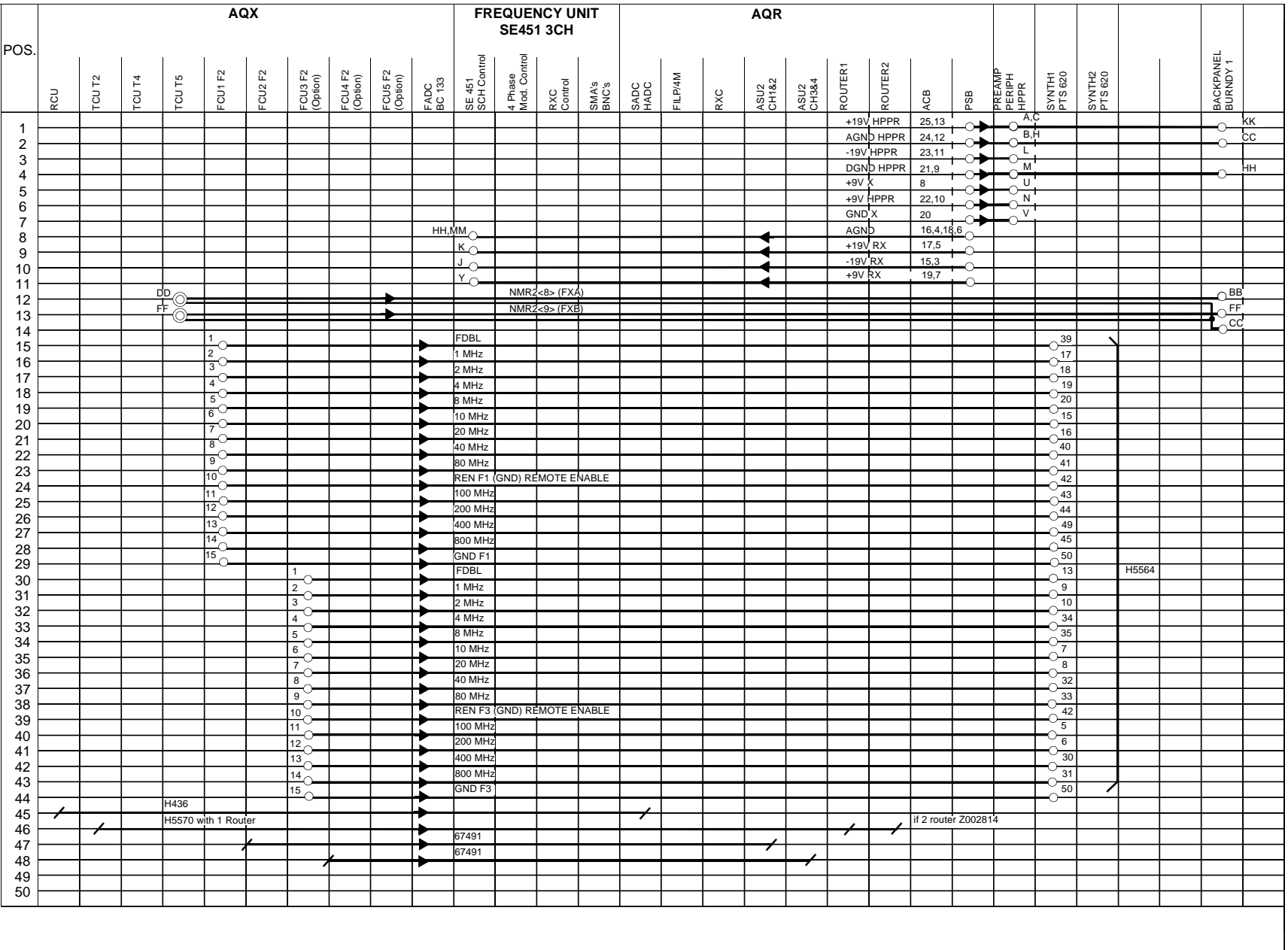

Table 5.2. Signal Name Periph. HPPR (RX22)

PIN	COAX Connections
D	NMR2<7> RCP Paswitch
E	TGPPA2 (SPPAX)
F	TGPF0 (SPFO)
G	RGP
J	TGPPA3(SPPAF19)
R	TGPA1(SPPAH)

PIN	DC Connections
A	+19V HPPR
B	AGND HPPR
C	+19V HPPR
H	AGND HPPR
K	
L	-19V HPPR
M	DGND HPPR
N	+9V HPPR
U	+9V X
V	GND X

Figure 4.3. AVANCE 2 bay SE451 DC Wiring Diagram Page 1



DC WIRING DIAGRAM Rec. SE451

Part-No. for Drawing only
 Drawing No. 12.04.94
 DMX/DXDC1

Drawn FDU
 Modification 28.09.94 28.03.95 05.09.95 03.07.96 12.02.97
 ESH FDU KST KST KST

ECL: 04

Sheet 1 of 3



Figure 4.3. AVANCE 2 bay SE451 HF Wiring Diagram Page 1

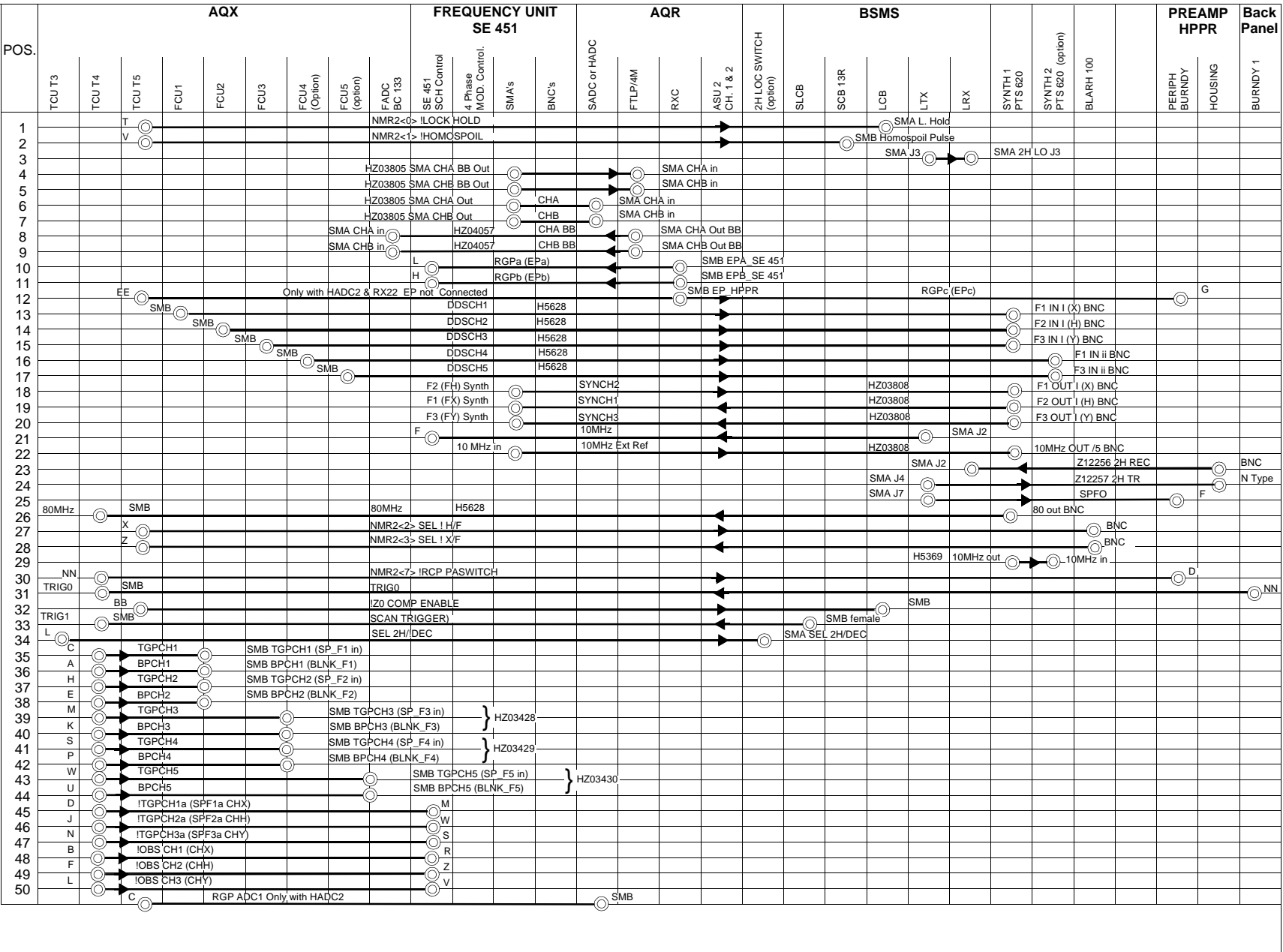

HF WIRING DIAGRAM Rec. SE451

Part-No. for Drawing only
 DMXDXSHF1
 Drawn
 FDU
 12.04.94

Modification
 ESH
 FDU
 KST
 KST
 KST
 24.10.94 28.03.95 14.09.95 03.07.96 12.02.97

ECL: 04

Sheet 1 of 3



Figure 4.3. AVANCE 2 bay SE451 HF Wiring Diagram Page 2

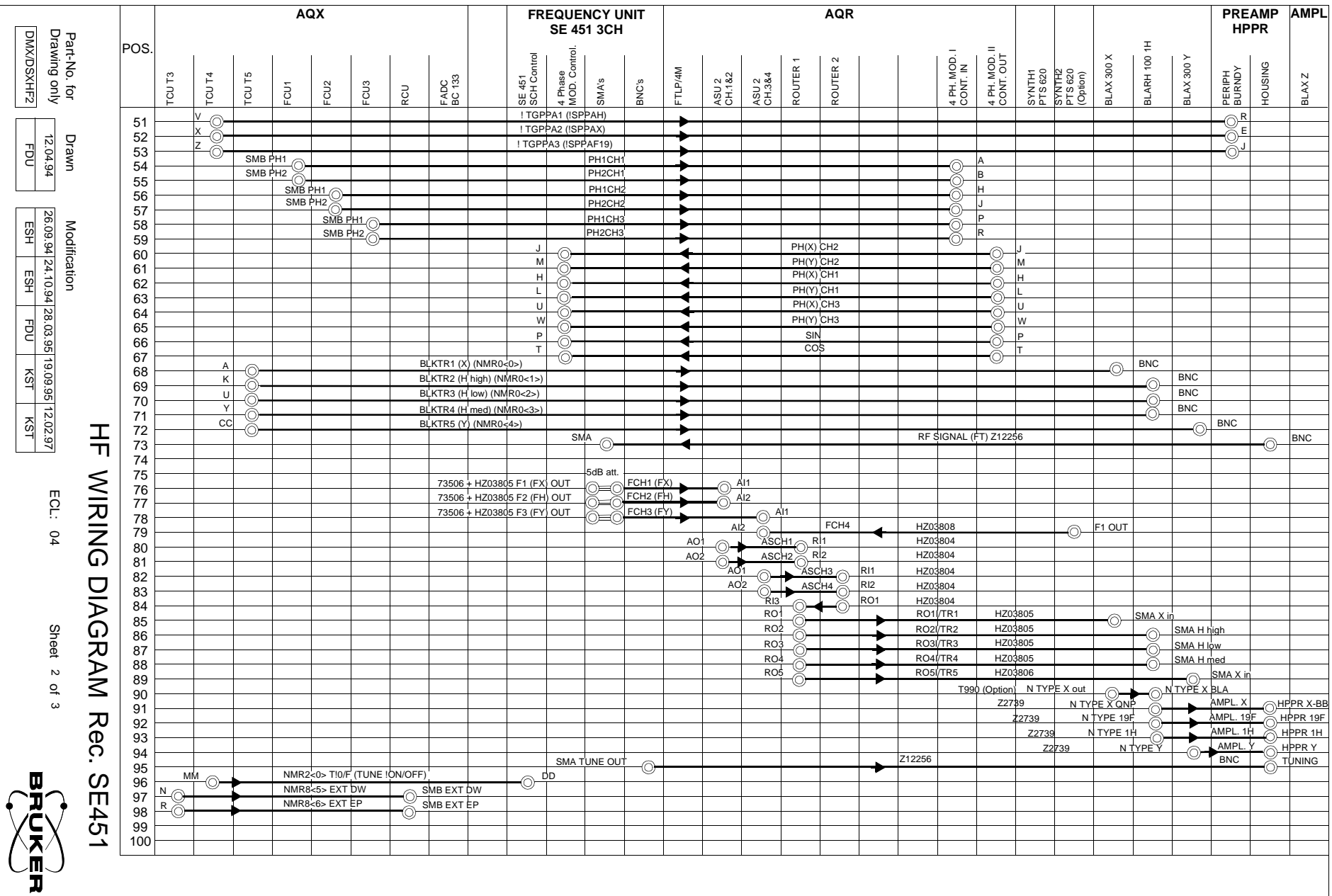

HF WIRING DIAGRAM Rec. SE451

Part-No. for Drawing only
 DMXDSXHFZ
 Drawn
 FDU
 12.04.94

Modification
 ESH ESH FDU KST
 26.09.94 24.10.94 28.03.95 19.09.95 12.02.97

ECL: 04

Sheet 2 of 3



Figure 4.3. AVANCE 2 bay SE451 HF Wiring Diagram Page 3

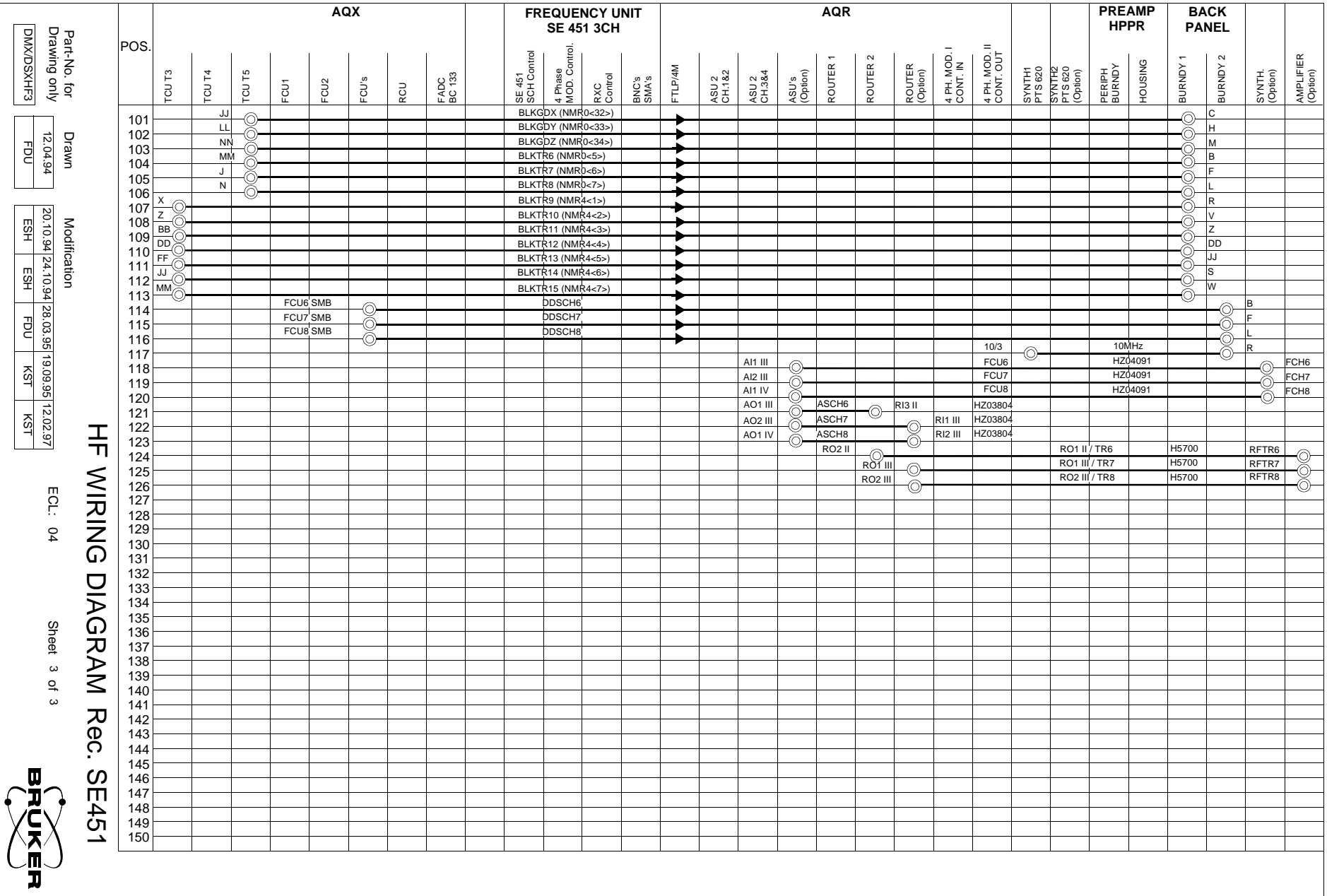

HF WIRING DIAGRAM Rec. SE451

Part-No. for Drawing only
 DMXDSXH3 FDU

Drawn 12.04.94
 Modification 20.10.94 24.10.94 28.03.95 19.09.95 12.02.97
 ESH ESH FDU KST KST

ECL: 04

Sheet 3 of 3



Figure 4.3. Backpanel Burndy1 & Burndy2 (SE451)

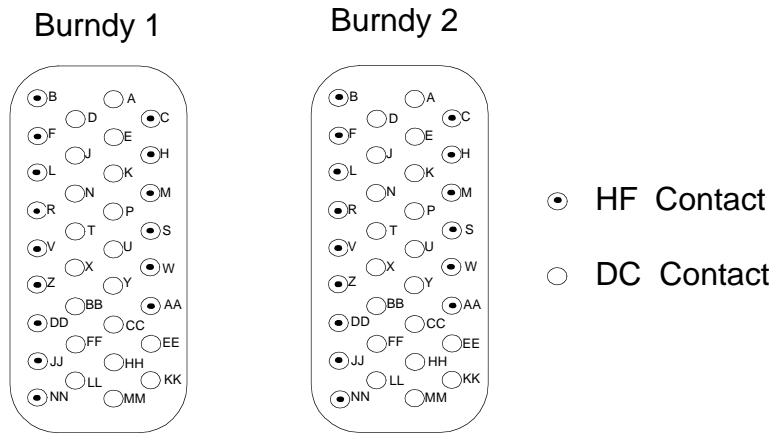

Table 4.1. Signal Name Burndy1 & Burndy2 (SE451)

COAX CONNECTIONS		
PIN	BURNDY 1	BURNDY 2
B	BLKTR6(NMR0<5<)	DDSCH6
F	BLKTR7(NMR0<6>)	DDSCH7
L	BLKTR8(NMR0<7>)	DDSCH8
R	BLKTR9(NMR4<1>)	10MHz
V	BLKTR10(NMR4<2>)	
Z	BLKTR11(NMR4<3>)	
DD	BLKTR12(NMR4<4>)	
JJ	BLKTR13(NMR4<5>)	
NN	TRIG0	
C	BLKGDY(NMR0<32>)	
H	BLKGDZ(NMR0<33>)	
M	BLKTR14(NMR4<6>)	
S	BLKTR15(NMR4<7>)	
AA	MIXCC(option)	

DC CONNECTIONS		
PIN	BURNDY 1	BURNDY 2
D		
J		
N		
T		
X		
BB	NMR2<8> (FXA)	
FF	NMR2<9> (FXB)	
LL		
A		
E		
K		
P		
U		
Y		
CC	AGND HPPR	
HH	DGND HPPR	
MM		
EE		
KK	+19V HPPR	

Figure 4.3. Backpanel Periph. HPPR (SE451)

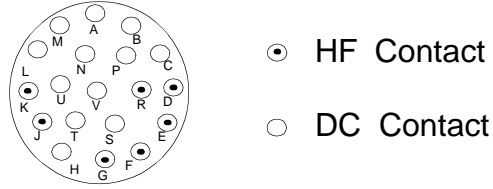

Table 4.1. Signal Name Periph. HPPR (SE451)

PIN	COAX Connections
D	NMR2<7> RCP Paswitch
E	TGPPA2 (SPPAX)
F	SPFO
G	RGPc (EPc)
J	TGPPA3(SPPAF19)
R	TGPPA1 (SPPAH)

PIN	DC Connections
A	+19V HPPR
B	AGND HPPR
C	+19V HPPR
H	AGND HPPR
K	
L	-19V HPPR
M	DGND HPPR
N	+9V HPPR
U	+9V X
V	GND X

Main Power Wiring

6

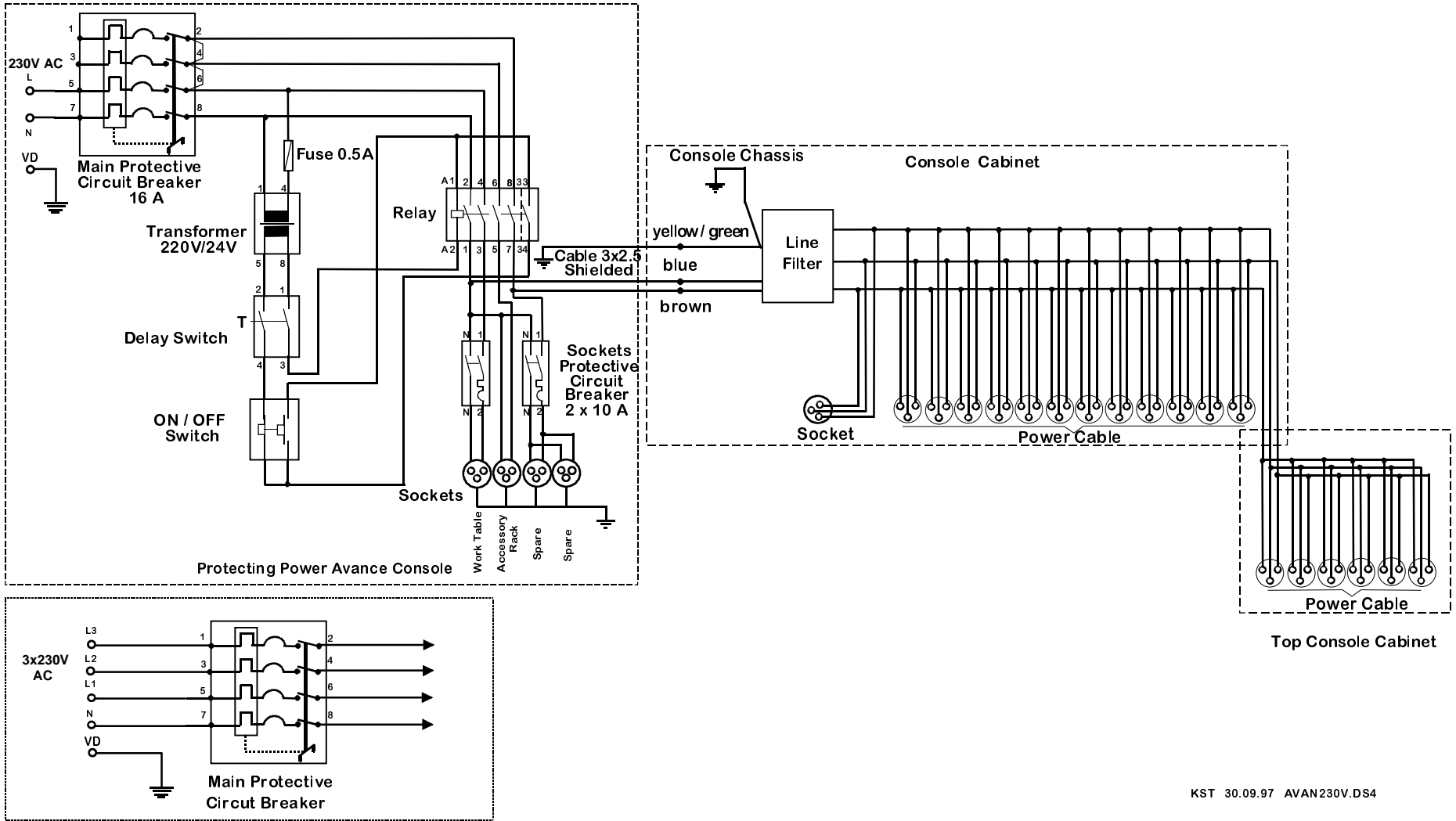
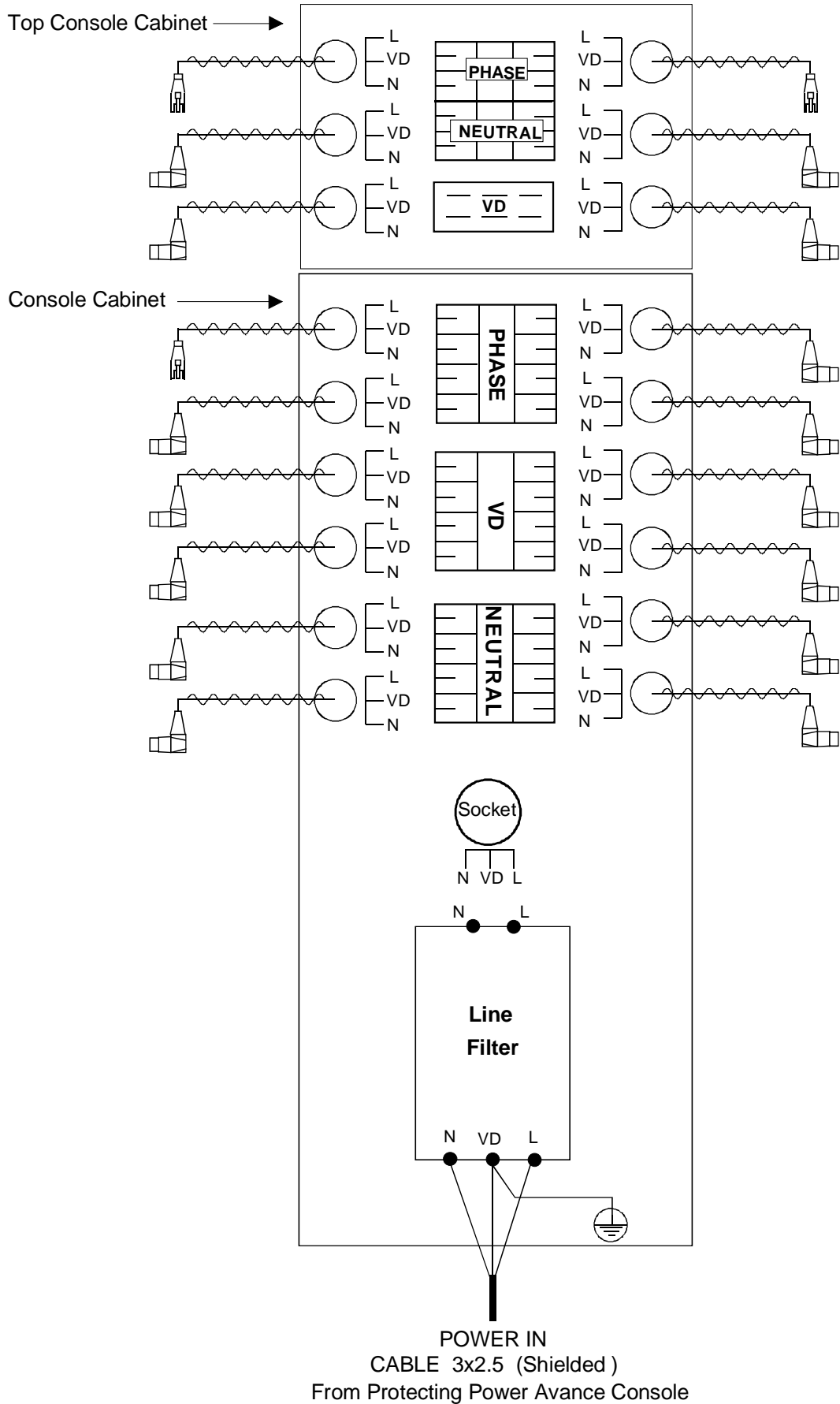

Figure 6.1. Avance 2 bay console Main Power Wiring

Figure 6.2. Avance 2 bay console Power Distribution 230V



KST 30.09.97 DIST230V.ds4

Figures

1	Safety Considerations	5
Figure 1.1.	Location of the ON/OFF Switch for the Console	7
Figure 1.2.	Location of Console Type Shield	8
Figure 1.3.	Location of the Fuses in the Console	9
2	Declaration of Conformity	11
3	Electrical Power Requirements	13
4	Console Configuration	17
Figure 4.1.	Avance 2 bay console Front View	18
Figure 4.2.	Avance 2 bay console Rear View	19
5	Internal Wiring	21
Figure 5.1.	Avance 2 bay RX22 DC Wiring Diagram Page 1	22
Figure 5.2.	Avance 2 bay RX22 DC Wiring Diagram Page 2	23
Figure 5.3.	Avance 2 bay RX22 DC Wiring Diagram Page 3	24
Figure 5.4.	Avance 2 bay RX22 HF Wiring Diagram Page 1	25
Figure 5.5.	Avance 2 bay RX22 HF Wiring Diagram Page 2	26
Figure 5.6.	Backpanel Burndy1 & Burndy2 (RX22)	27
Figure 5.7.	Backpanel Periph. HPPR (RX22)	28
Figure 4.3.	AVANCE 2 bay SE451 DC Wiring Diagram Page 1	29
Figure 4.3.	AVANCE 2 bay SE451 DC Wiring Diagram Page 2	30
Figure 4.3.	AVANCE 2 bay SE451 DC Wiring Diagram Page 3	31
Figure 4.3.	AVANCE 2 bay SE451 HF Wiring Diagram Page 1	32
Figure 4.3.	AVANCE 2 bay SE451 HF Wiring Diagram Page 2	33
Figure 4.3.	AVANCE 2 bay SE451 HF Wiring Diagram Page 3	34
Figure 4.3.	Backpanel Burndy1 & Burndy2 (SE451)	35
Figure 4.3.	Backpanel Periph. HPPR (SE451)	36
6	Main Power Wiring	37
Figure 6.1.	Avance 2 bay console Main Power Wiring	38
Figure 6.2.	Avance 2 bay console Power Distribution 230V	39

Tables

1	Safety Considerations	5
2	Declaration of Conformity	11
3	Electrical Power Requirements	13
Table 3.1.	Power Requirements of Basic System (2 Channels)	13
Table 3.2.	Console Powered Units	14
Table 3.3.	Units That Require Separate Power Units	14
4	Console Configuration	17
5	Internal Wiring	21
Table 5.1.	Signal Name Burndy1 & Burndy2 (RX22)	27
Table 5.2.	Signal Name Periph. HPPR (RX22)	28
Table 4.1.	Signal Name Burndy1 & Burndy2 (SE451)	35
Table 4.1.	Signal Name Periph. HPPR (SE451)	36
6	Main Power Wiring	37

