

AQR

**Amplitude Setting Unit Single
Technical Manual**

Version 001

BRUKER

The information in this manual may be altered without notice.

BRUKER accepts no responsibility for actions taken as a result of use of this manual. BRUKER accepts no liability for any mistakes contained in the manual, leading to coincidental damage, whether during installation or operation of the instrument. Unauthorised reproduction of manual contents, without written permission from the publishers, or translation into another language, either in full or in part, is forbidden.

This manual was written by

BARTHÉLÉMY Philippe

© October 29, 1998: Bruker SA

Wissembourg, France

Manual P/N: Z31485

DWG-Nr: 1187001

Contents

	Contents	3
	Index	5
1	ASU Single Channel	7
2	Interface	11
2.1	Inputs / Outputs Connectors	17
3	MMA Unit.....	19
4	Specifications	33
4.1	Characteristics of Amplitude Setting Unit Single Channel ...	33
	RF specifications	33
	Amplitude control	33
	Safety switch	33
	Dynamics	34
	Phase shift	34
	Isolation (SPENAB CMD), (MOD & MULT at max. level) ..	34
	Output noise level	34
	Switching time	34
	DC requirements	34
	Operating temperature	35
	Figures	37
	Tables	39

Index

W

W4B132115 B.....	9
W4B132129 B.....	20
W4D132104.....	14
W4L131102 B.....	31
W4L131509 B.....	27
W4L131510 B.....	22
W4L132131 B.....	8
W4L132197.....	13
W4S131509 B.....	26
W4S131510 B.....	21
W4S132081.....	30
W4S132197.....	12
W4W132130 B.....	10

ASU Single Channel

1

Figure 1.1. Amplitude Setting Unit Single Channel Location

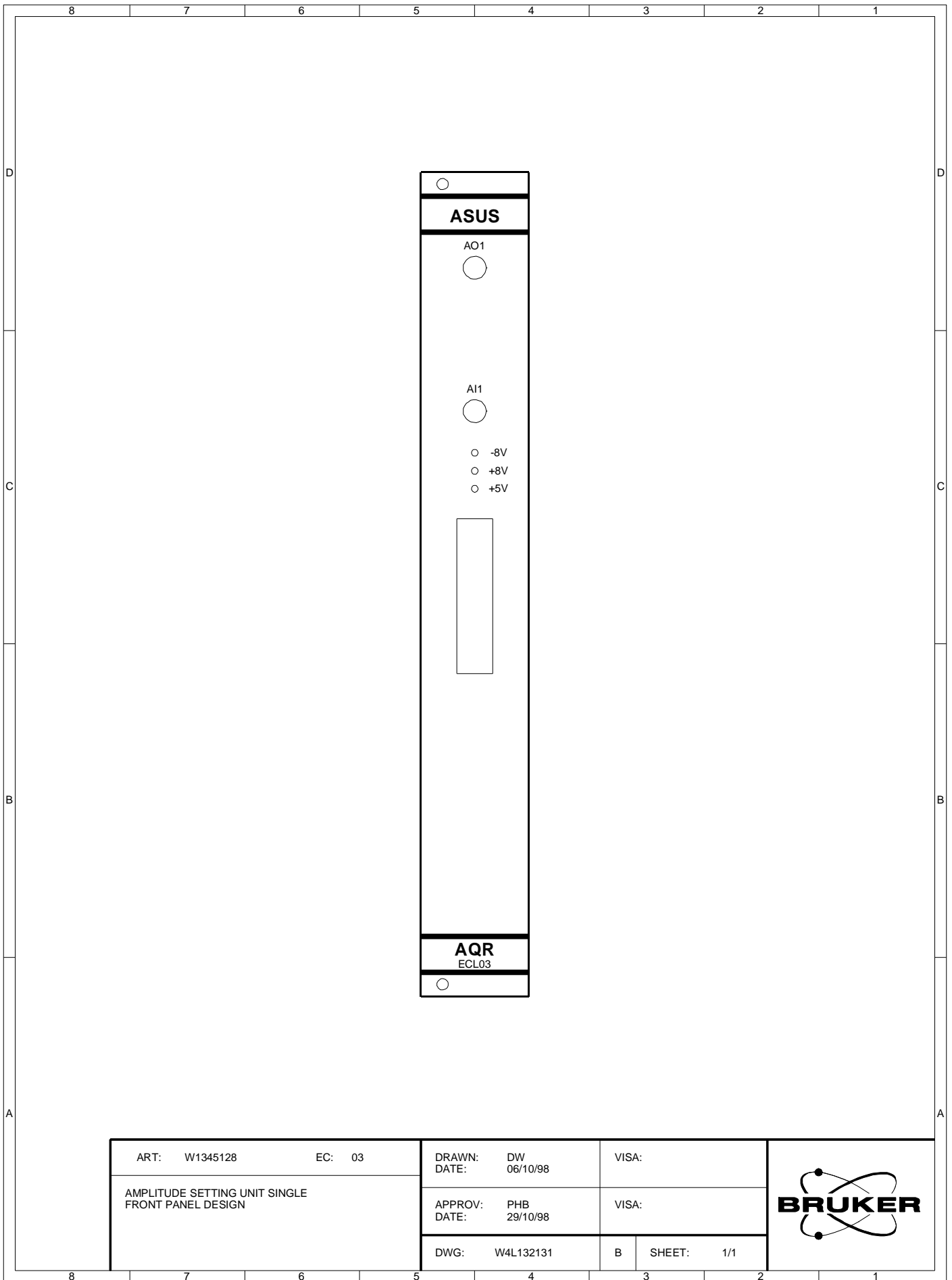

ART: W1345128	EC: 03	DRAWN: DW	DATE: 06/10/98	VISA:
AMPLITUDE SETTING UNIT SINGLE FRONT PANEL DESIGN		APPROV: PHB	DATE: 29/10/98	VISA:
		DWG: W4L132131	B	SHEET: 1/1



Figure 1.2. Amplitude Setting Unit Single Channel Block Diagram

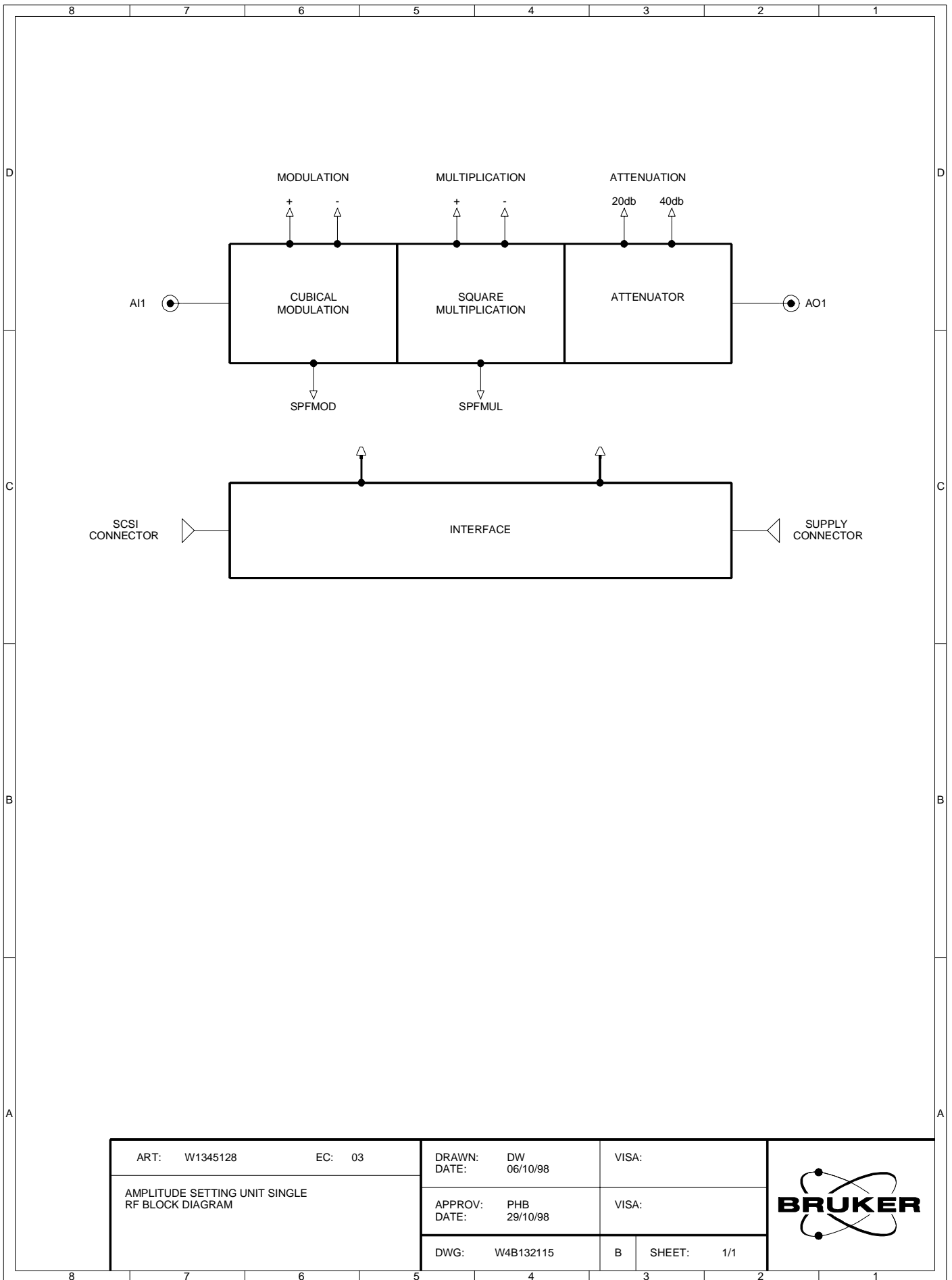

ART: W1345128	EC: 03	DRAWN: DW	VISA:
AMPLITUDE SETTING UNIT SINGLE RF BLOCK DIAGRAM		DATE: 06/10/98	
		APPROV: PHB	VISA:
		DATE: 29/10/98	
DWG: W4B132115	B	SHEET: 1/1	



Figure 1.3. Amplitude Setting Unit Single Channel Wiring Diagram

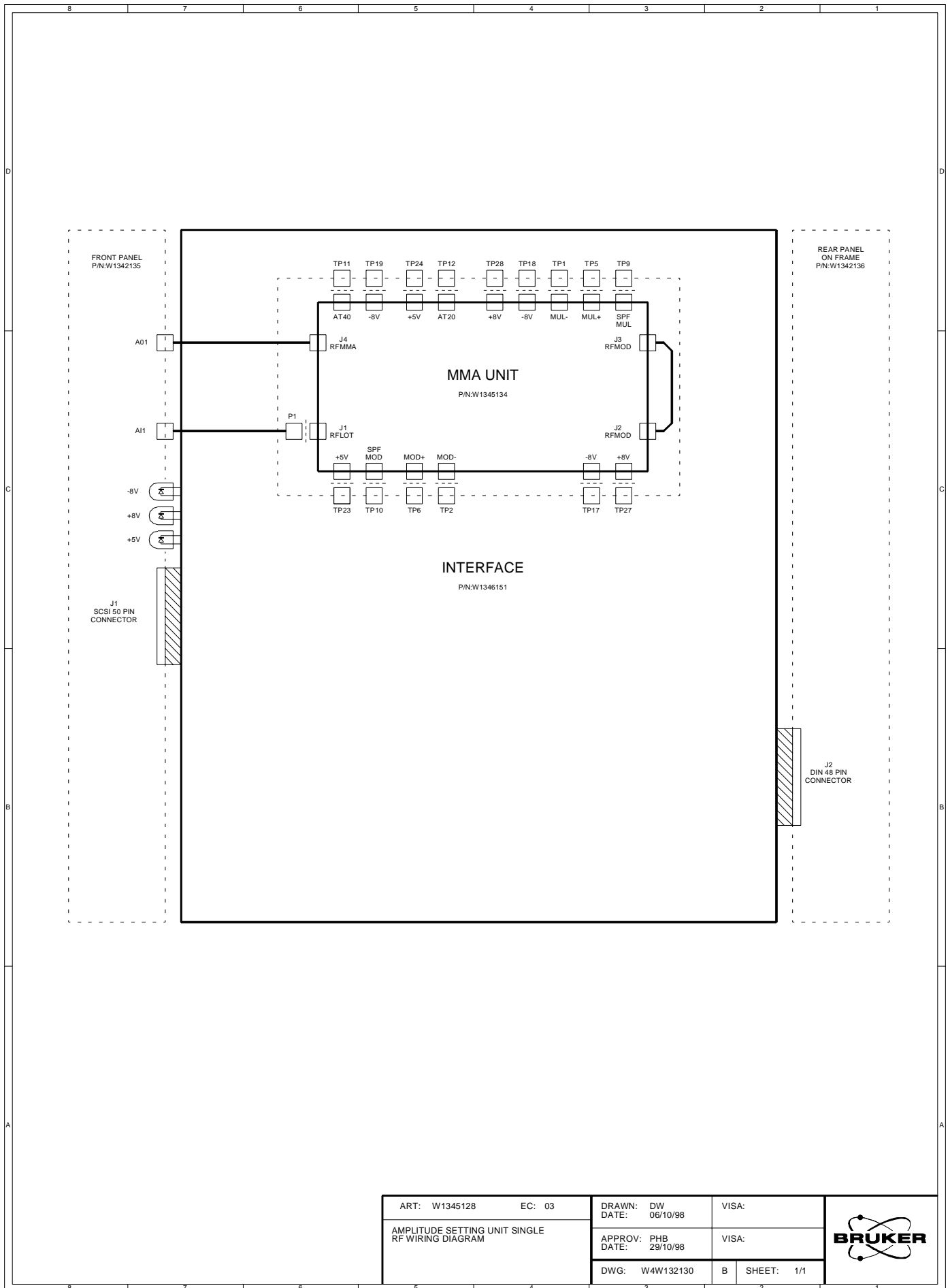

ART: W1345128	EC: 03	DRAWN: DW DATE: 06/10/98	VISA:
AMPLITUDE SETTING UNIT SINGLE RF WIRING DIAGRAM		APPROV: PHB DATE: 29/10/98	VISA:
		DWG: W4W132130	B SHEET: 1/1



Interface

2

Figure 2.1. Interface Schematic

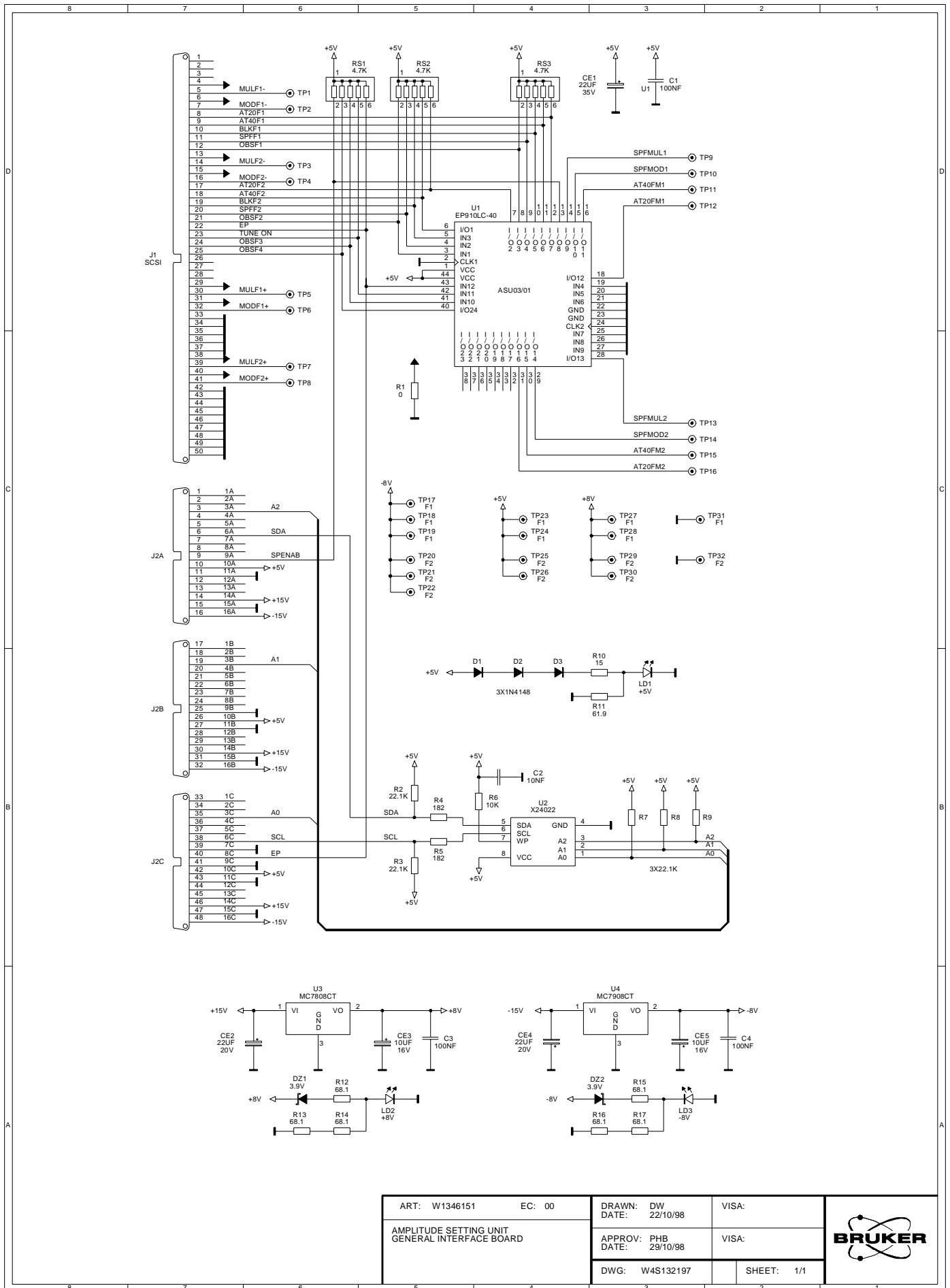

ART: W1346151	EC: 00	DRAWN: DW DATE: 22/10/98	VISA:
AMPLITUDE SETTING UNIT GENERAL INTERFACE BOARD		APPROV: PHB DATE: 29/10/98	VISA:
		DWG: W4S132197	SHEET: 1/1



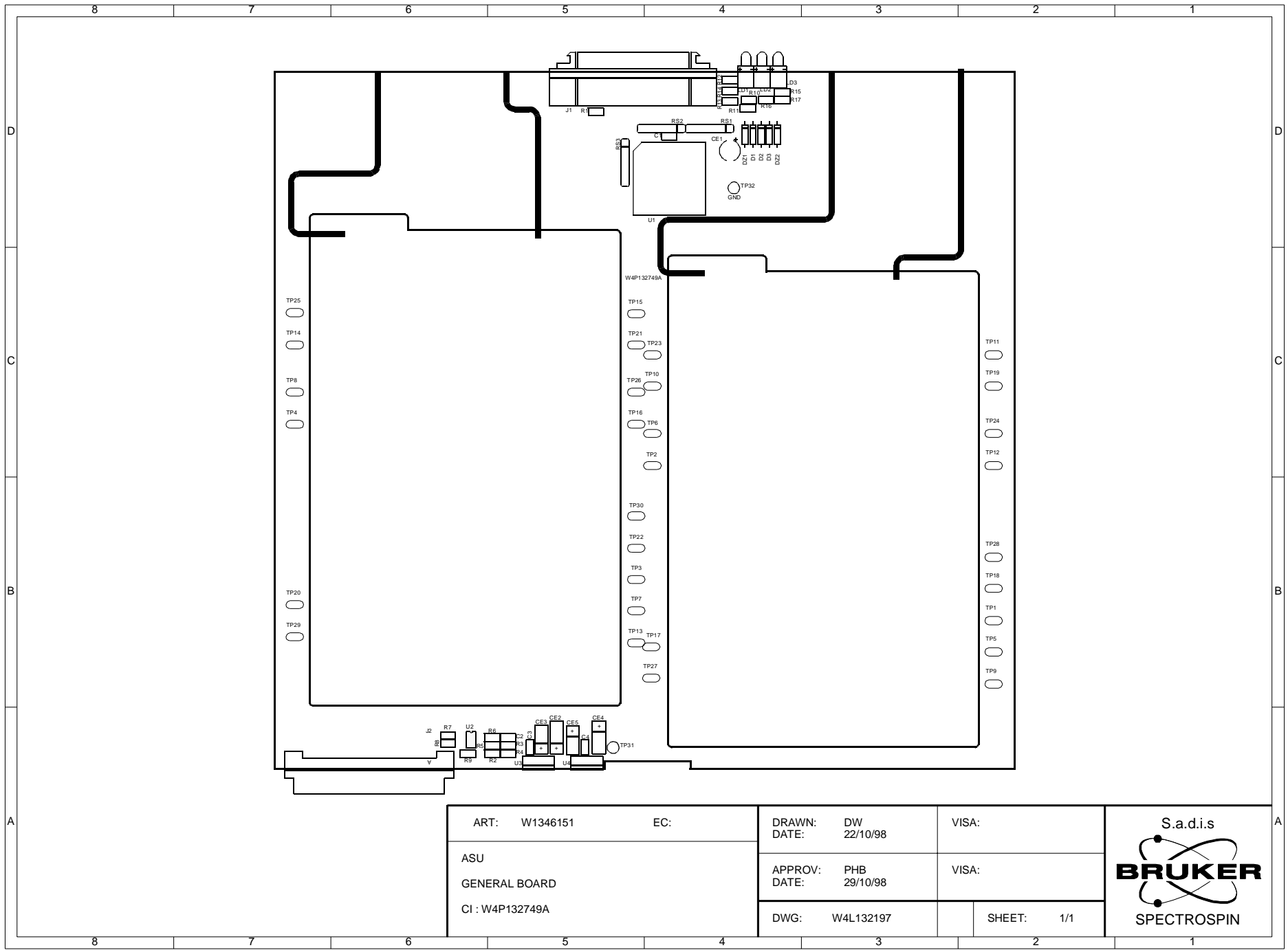
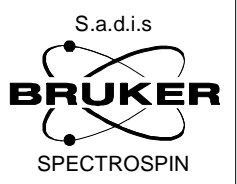

Figure 2.2. Interface Location



Value Table

Value Tab Head			
Part:W1346151 Drawing:W4S132197		Copy In Part:	
Desc:AQR ASU CIRCUIT INTERFACE		ECL:0	Modified:22/10/98
Value Tab		Draw: By:DW	
Pos.	Component	Local Description	
C1	8493	COND CMS 1206 100N 50V 20% X7R	
C2	21014	COND CMS 1206 10N 50V 20% X7R	
C3	8493	COND CMS 1206 100N 50V 20% X7R	
C4	8493	COND CMS 1206 100N 50V 20% X7R	
CE1	10017	COND CHIMI RAD 22U 35V 6.3X7	
CE2	51557	COND CMS TANTAL 22U 20V 20%	
CE3	51559	COND CMS TANTAL 10U 16V 20%	
CE4	51557	COND CMS TANTAL 22U 20V 20%	
CE5	51559	COND CMS TANTAL 10U 16V 20%	
CI1	W1348018	CI ASU2/LOT CIRCUIT INTERFACE	
D1	2967	DIODE 1N4148	
D2	2967	DIODE 1N4148	
D3	2967	DIODE 1N4148	
DZ1	34639	DIODE Z BZX55C 3.9V 500MW	
DZ2	34639	DIODE Z BZX55C 3.9V 500MW	
ICSU1	15771	IC SUPPORT PLCC44	
J1	59837	CN F 50 C PRT SCSI/1.27	
J2	22744	CN M 48 C PRT DIN41612-C/2	
LD1	21866	OPTO LED 3MM C PRT BOI VR R2.5	
LD2	21866	OPTO LED 3MM C PRT BOI VR R2.5	
LD3	21866	OPTO LED 3MM C PRT BOI VR R2.5	
R1	21352	RES CMS 0 1% 0.25W 1206	
R2	21327	RES CMS 22.1K 1% 0.25W 1206	
R3	21327	RES CMS 22.1K 1% 0.25W 1206	
R4	20727	RES CMS 182 1% 0.25W 1206	
R5	20727	RES CMS 182 1% 0.25W 1206	
R6	20750	RES CMS 10K 1% 0.25W 1206	
R7	21327	RES CMS 22.1K 1% 0.25W 1206	
R8	21327	RES CMS 22.1K 1% 0.25W 1206	
R9	21327	RES CMS 22.1K 1% 0.25W 1206	
R10	20713	RES CMS 15 1% 0.25W 1206	
R11	8853	RES CMS 61.9 1% 0.25W 1206	
R12	20721	RES CMS 68.1 1% 0.25W 1206	
R13	20721	RES CMS 68.1 1% 0.25W 1206	
R14	20721	RES CMS 68.1 1% 0.25W 1206	
R15	20721	RES CMS 68.1 1% 0.25W 1206	
R16	20721	RES CMS 68.1 1% 0.25W 1206	
R17	20721	RES CMS 68.1 1% 0.25W 1206	
RS1	9818	RES RES 4.7KX5 2% SIL6	
RS2	9818	RES RES 4.7KX5 2% SIL6	
RS3	9818	RES RES 4.7KX5 2% SIL6	
TP1	35779	ACCBL LANGUETTE PL 2.8 PRT	
TP2	35779	ACCBL LANGUETTE PL 2.8 PRT	
TP3	35779	ACCBL LANGUETTE PL 2.8 PRT	
TP4	35779	ACCBL LANGUETTE PL 2.8 PRT	
TP5	35779	ACCBL LANGUETTE PL 2.8 PRT	
TP6	35779	ACCBL LANGUETTE PL 2.8 PRT	
TP7	35779	ACCBL LANGUETTE PL 2.8 PRT	
TP8	35779	ACCBL LANGUETTE PL 2.8 PRT	
TP9	35779	ACCBL LANGUETTE PL 2.8 PRT	
TP10	35779	ACCBL LANGUETTE PL 2.8 PRT	
TP11	35779	ACCBL LANGUETTE PL 2.8 PRT	
TP12	35779	ACCBL LANGUETTE PL 2.8 PRT	
TP13	35779	ACCBL LANGUETTE PL 2.8 PRT	

Interface

```

+-- Value Tab Head -----+
| Part:W1346151 Drawing:W4S132197          Copy In Part:          Draw:          |
| Desc:AQR ASU CIRCUIT INTERFACE          ECL:0          Modified:22/10/98      By:DW          |
+-- Value Tab -----+
| Pos.          Component          Local Description          |
| TP14          35779          ACCBL LANGUETTE PL 2.8 PRT |
| TP15          35779          ACCBL LANGUETTE PL 2.8 PRT |
| TP16          35779          ACCBL LANGUETTE PL 2.8 PRT |
| TP17          35779          ACCBL LANGUETTE PL 2.8 PRT |
| TP18          35779          ACCBL LANGUETTE PL 2.8 PRT |
| TP19          35779          ACCBL LANGUETTE PL 2.8 PRT |
| TP20          35779          ACCBL LANGUETTE PL 2.8 PRT |
| TP21          35779          ACCBL LANGUETTE PL 2.8 PRT |
| TP22          35779          ACCBL LANGUETTE PL 2.8 PRT |
| TP23          35779          ACCBL LANGUETTE PL 2.8 PRT |
| TP24          35779          ACCBL LANGUETTE PL 2.8 PRT |
| TP25          35779          ACCBL LANGUETTE PL 2.8 PRT |
| TP26          35779          ACCBL LANGUETTE PL 2.8 PRT |
| TP27          35779          ACCBL LANGUETTE PL 2.8 PRT |
| TP28          35779          ACCBL LANGUETTE PL 2.8 PRT |
| TP29          35779          ACCBL LANGUETTE PL 2.8 PRT |
| TP30          35779          ACCBL LANGUETTE PL 2.8 PRT |
| TP31          59995          ACCBL PICOT FOURCHE D1.1MM |
| TP32          59995          ACCBL PICOT FOURCHE D1.1MM |
| TP3           35779          ACCBL LANGUETTE PL 2.8 PRT |
| TP4           35779          ACCBL LANGUETTE PL 2.8 PRT |
| TP5           35779          ACCBL LANGUETTE PL 2.8 PRT |
| TP6           35779          ACCBL LANGUETTE PL 2.8 PRT |
| TP7           35779          ACCBL LANGUETTE PL 2.8 PRT |
| TP8           35779          ACCBL LANGUETTE PL 2.8 PRT |
| TP9           35779          ACCBL LANGUETTE PL 2.8 PRT |
| U1            W1356607          IC 910/ASU CIRCUIT INTERFACE |
| U2            22952          IC 24022/E2PR X24022S8 SO8   |
| U3            4978           IC 7808/VREG MC7808CT TO220  |
| U4            12156          IC 7908/VREG MC7908CT TO220  |
+-----+

```

Table 2.1. Front Panel Connector J1

Pins	Descriptions	Pins	Descriptions
01	NC	26	NC
02	NC	27	NC
03	NC	28	NC
04	AGND	29	AGND
05	MULF1-	30	MULF1+
06	AGND	31	AGND
07	MODF1-	32	MODF1+
08	AT20F1	33	DGND
09	AT40F1	34	DGND
10	BLKF1	35	DGND
11	SPFF1	36	DGND
12	OBSF1	37	DGND
13	AGND	38	AGND
14	MULF2-	39	MULF2+
15	AGND	40	AGND
16	MODF2-	41	MODF2+
17	AT20F2	42	DGND
18	AT40F2	43	DGND
19	BLKF2	44	DGND
20	SPFF2	45	DGND
21	OBSF2	46	DGND
22	NC	47	DGND
23	TUNE ON	48	DGND
24	NC	49	DGND
25	NC	50	DGND

Table 2.2. Rear Panel Connector J2

Pins	Descriptions	Pins	Descriptions	Pins	Descriptions
1A	NC	1B	NC	1C	NC
2A	NC	2B	NC	2C	NC
3A	Adresse 1	3B	Adresse 2	3C	Adresse 3
4A	NC	4B	NC	4C	NC
5A	NC	5B	NC	5C	NC
6A	SDA	6B	NC	6C	SCL
7A	NC	7B	NC	7C	I2CGND
8A	NC	8B	NC	8C	EP
9A	SPENAB	9B	SPENABGND	9C	EPGND
10A	+5V	10B	+5V	10C	+5V
11A	GND	11B	GND	11C	GND
12A	NC	12B	NC	12C	NC
13A	NC	13B	NC	13C	NC
14A	+15V	14B	+15V	14C	+15V
15A	GND	15B	GND	15C	GND
16A	-15V	16B	-15V	16C	-15V

MMA Unit

3

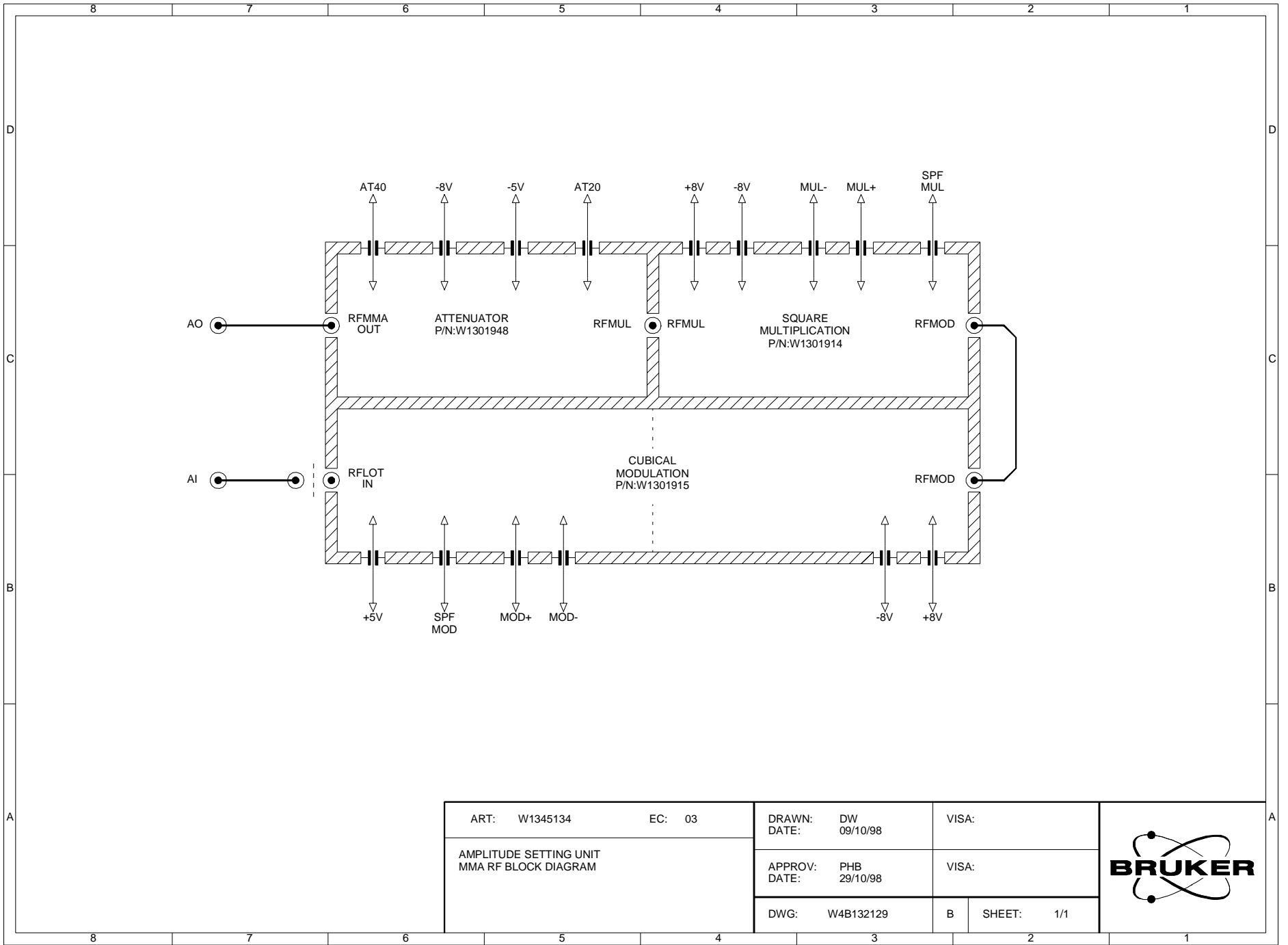

Figure 3.1. Modulation, Multiplication & Attenuator Block Diagram

ART: W1345134	EC: 03	DRAWN: DW	VISA:
AMPLITUDE SETTING UNIT MMA RF BLOCK DIAGRAM		DATE: 09/10/98	
		APPROV: PHB	VISA:
		DATE: 29/10/98	
DWG: W4B132129	B	SHEET: 1/1	

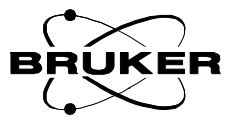
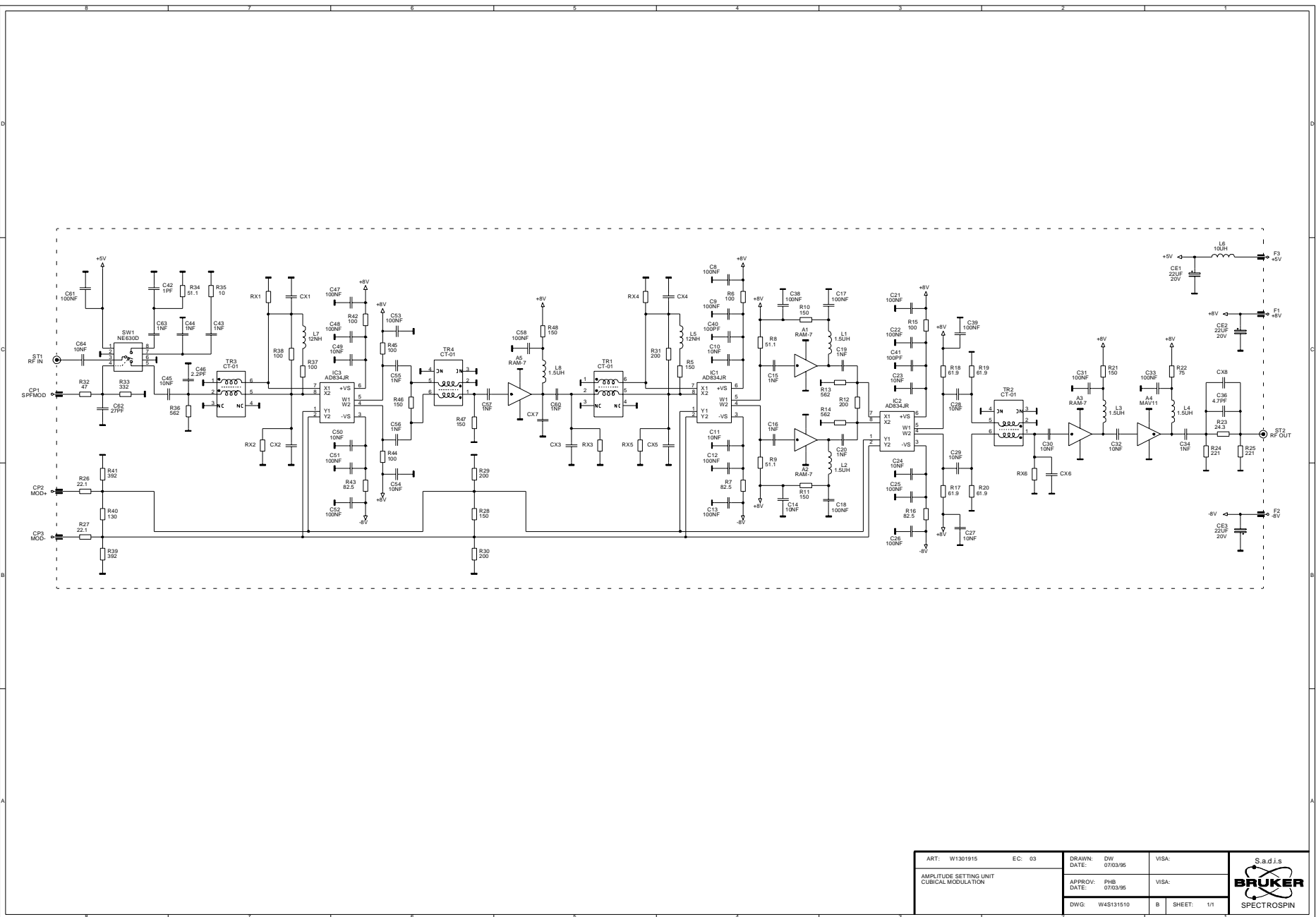

Figure 3.2. Modulation Schematic



ART: W1301915	EC: 03	DRAWN: DW 07503/95	VISA:
AMPLITUDE SETTING UNIT CUBICAL MODULATION		APPROV: PHB 07503/95	VISA:
		DWG: W45131510	B SHEET: 1/1



Figure 3.3. Modulation Location

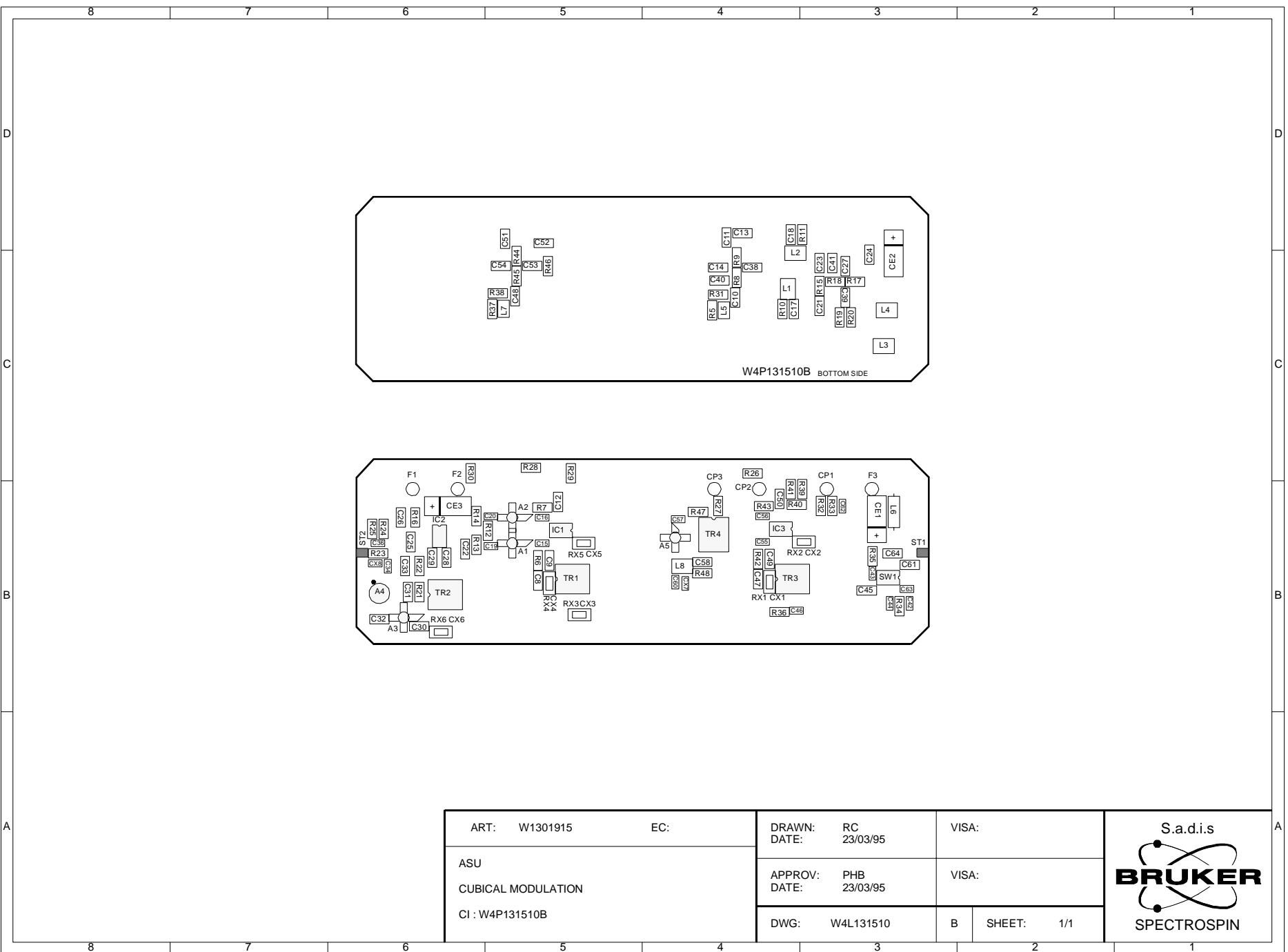

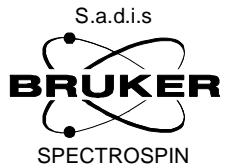
ART: W1301915	EC:	DRAWN: RC	VISA:	
ASU		DATE: 23/03/95		
CUBICAL MODULATION		APPROV: PHB	VISA:	
CI : W4P131510B		DATE: 23/03/95		
		DWG: W4L131510	B	SHEET: 1/1

Value Table

```

+-- Value Tab Head -----+
| Part:W1301915 Drawing:W4S131510B          Copy In Part:          Draw:          |
| Desc:ASU MODULATION AU CUBE                ECL:0                Modified:06/03/95      By:DEHF          |
+-- Value Tab -----+
|      Pos.      Component      Local Description      |
|-----|-----|-----|
|      A1      56535      IC 7/HF RAM-7 13DB EQU.MSA0735 |
|      A2      56535      IC 7/HF RAM-7 13DB EQU.MSA0735 |
|      A3      56535      IC 7/HF RAM-7 13DB EQU.MSA0735 |
|      A4      31201      IC 11/HF MAV-11          |
|      A5      56535      IC 7/HF RAM-7 13DB EQU.MSA0735 |
|      C8      8493      COND CMS 1206 100N 50V 20% X7R |
|      C9      8493      COND CMS 1206 100N 50V 20% X7R |
|      C10     21014     COND CMS 1206 10N 50V 20% X7R   |
|      C11     21014     COND CMS 1206 10N 50V 20% X7R   |
|      C12     8493      COND CMS 1206 100N 50V 20% X7R |
|      C13     8493      COND CMS 1206 100N 50V 20% X7R |
|      C14     21014     COND CMS 1206 10N 50V 20% X7R   |
|      C15     73183     COND CMS CDR12 1N 150V 20%      |
|      C16     73183     COND CMS CDR12 1N 150V 20%      |
|      C17     8493      COND CMS 1206 100N 50V 20% X7R |
|      C18     8493      COND CMS 1206 100N 50V 20% X7R |
|      C19     73183     COND CMS CDR12 1N 150V 20%      |
|      C20     73183     COND CMS CDR12 1N 150V 20%      |
|      C21     8493      COND CMS 1206 100N 50V 20% X7R |
|      C22     8493      COND CMS 1206 100N 50V 20% X7R |
|      C23     21014     COND CMS 1206 10N 50V 20% X7R   |
|      C24     21014     COND CMS 1206 10N 50V 20% X7R   |
|      C25     8493      COND CMS 1206 100N 50V 20% X7R |
|      C26     8493      COND CMS 1206 100N 50V 20% X7R |
|      C27     21014     COND CMS 1206 10N 50V 20% X7R   |
|      C28     21014     COND CMS 1206 10N 50V 20% X7R   |
|      C29     21014     COND CMS 1206 10N 50V 20% X7R   |
|      C30     21014     COND CMS 1206 10N 50V 20% X7R   |
|      C31     8493      COND CMS 1206 100N 50V 20% X7R |
|      C32     21014     COND CMS 1206 10N 50V 20% X7R   |
|      C33     8493      COND CMS 1206 100N 50V 20% X7R |
|      C34     73183     COND CMS CDR12 1N 150V 20%      |
|      C36     73180     COND CMS CDR12 4.7P 150V 0.25P  |
|      C38     8493      COND CMS 1206 100N 50V 20% X7R |
|      C39     8493      COND CMS 1206 100N 50V 20% X7R |
|      C40     20990     COND CMS 1206 100P 50V 5% NPO   |
|      C41     20990     COND CMS 1206 100P 50V 5% NPO   |
|      C42     73410     COND CMS CDR12 1P 150V 0.25P    |
|      C43     73183     COND CMS CDR12 1N 150V 20%      |
|      C44     73183     COND CMS CDR12 1N 150V 20%      |
|      C45     21014     COND CMS 1206 10N 50V 20% X7R   |
|      C46     73179     COND CMS CDR12 2.2P 150V 0.25P   |
|      C47     8493      COND CMS 1206 100N 50V 20% X7R |
|      C48     8493      COND CMS 1206 100N 50V 20% X7R |
|      C49     21014     COND CMS 1206 10N 50V 20% X7R   |
|      C50     21014     COND CMS 1206 10N 50V 20% X7R   |
|      C51     8493      COND CMS 1206 100N 50V 20% X7R |
|      C52     8493      COND CMS 1206 100N 50V 20% X7R |
|      C53     8493      COND CMS 1206 100N 50V 20% X7R |
|      C54     21014     COND CMS 1206 10N 50V 20% X7R   |
|      C55     73183     COND CMS CDR12 1N 150V 20%      |
|      C56     73183     COND CMS CDR12 1N 150V 20%      |
|      C57     73183     COND CMS CDR12 1N 150V 20%      |
|      C58     8493      COND CMS 1206 100N 50V 20% X7R |

```

MMA Unit

```

+-- Value Tab Head -----+
| Part:W1301915 Drawing:W4S131510B          Copy In Part:          Draw:          |
| Desc:ASU MODULATION AU CUBE                ECL:0                    Modified:06/03/95        By:DEHF          |
+-- Value Tab -----+
| Pos.      Component      Local Description      |
| C60       73183          COND CMS CDR12 1N 150V 20% |
| C61       8493          COND CMS 1206 100N 50V 20% X7R |
| C62       73182          COND CMS CDR12 27P 150V 20% |
| C63       73183          COND CMS CDR12 1N 150V 20% |
| C64       21014          COND CMS 1206 10N 50V 20% X7R |
| CE1       51557          COND CMS TANTAL 22U 20V 20% |
| CE2       51557          COND CMS TANTAL 22U 20V 20% |
| CE3       51557          COND CMS TANTAL 22U 20V 20% |
| CI1       W1356520       CI MODULATION AU CUBE |
| CP1       59995          ACCBL PICOT FOURCHE D1.1MM |
| CP2       59995          ACCBL PICOT FOURCHE D1.1MM |
| CP3       59995          ACCBL PICOT FOURCHE D1.1MM |
| F1        59995          ACCBL PICOT FOURCHE D1.1MM |
| F2        59995          ACCBL PICOT FOURCHE D1.1MM |
| F3        59995          ACCBL PICOT FOURCHE D1.1MM |
| IC1       56510          IC 834/PAD AD834MULT 0.5GHZSO8 |
| IC2       56510          IC 834/PAD AD834MULT 0.5GHZSO8 |
| IC3       56510          IC 834/PAD AD834MULT 0.5GHZSO8 |
| L1        22874          SELF CMS 1008 1.5UH 10% |
| L2        22874          SELF CMS 1008 1.5UH 10% |
| L3        22874          SELF CMS 1008 1.5UH 10% |
| L4        22874          SELF CMS 1008 1.5UH 10% |
| L5        42179          SELF CMS 1008 12NH 20% |
| L6        30155          SELF 10UH 0.14A |
| L7        42179          SELF CMS 1008 12NH 20% |
| L8        22874          SELF CMS 1008 1.5UH 10% |
| R10       20726          RES CMS 150 1% 0.25W 1206 |
| R11       20726          RES CMS 150 1% 0.25W 1206 |
| R12       8854          RES CMS 200 1% 0.25W 1206 |
| R13       20733          RES CMS 562 1% 0.25W 1206 |
| R14       20733          RES CMS 562 1% 0.25W 1206 |
| R15       20724          RES CMS 100 1% 0.25W 1206 |
| R16       20722          RES CMS 82.5 1% 0.25W 1206 |
| R17       8853          RES CMS 61.9 1% 0.25W 1206 |
| R18       8853          RES CMS 61.9 1% 0.25W 1206 |
| R19       8853          RES CMS 61.9 1% 0.25W 1206 |
| R20       8853          RES CMS 61.9 1% 0.25W 1206 |
| R21       20726          RES CMS 150 1% 0.25W 1206 |
| R22       51836          RES CMS 75 1% 0.25W 1206 |
| R23       56359          RES CMS 24.3 1% 0.25W 1206 |
| R24       20728          RES CMS 221 1% 0.25W 1206 |
| R25       20728          RES CMS 221 1% 0.25W 1206 |
| R26       20715          RES CMS 22.1 1% 0.25W 1206 |
| R27       20715          RES CMS 22.1 1% 0.25W 1206 |
| R28       20726          RES CMS 150 1% 0.25W 1206 |
| R29       8854          RES CMS 200 1% 0.25W 1206 |
| R30       8854          RES CMS 200 1% 0.25W 1206 |
| R31       8854          RES CMS 200 1% 0.25W 1206 |
| R32       73283          RES CMS 47.5 1% 0.25W 1206 |
| R33       20730          RES CMS 332 1% 0.25W 1206 |
| R34       20765          RES CMS 51.1 1% 0.25W 1206 |
| R35       20711          RES CMS 10 1% 0.25W 1206 |
| R36       20733          RES CMS 562 1% 0.25W 1206 |
| R37       20724          RES CMS 100 1% 0.25W 1206 |
| R38       20724          RES CMS 100 1% 0.25W 1206 |
| R39       20731          RES CMS 392 1% 0.25W 1206 |

```

+-- Value Tab Head -----+			
Part:W1301915 Drawing:W4S131510B		Copy In Part:	Draw:
Desc:ASU MODULATION AU CUBE		ECL:0	Modified:06/03/95 By:DEHF
+-- Value Tab -----+			
Pos.	Component	Local Description	
R40	51682	RES CMS 130 1% 0.25W 1206	
R41	20731	RES CMS 392 1% 0.25W 1206	
R42	20724	RES CMS 100 1% 0.25W 1206	
R43	20722	RES CMS 82.5 1% 0.25W 1206	
R44	20724	RES CMS 100 1% 0.25W 1206	
R45	20724	RES CMS 100 1% 0.25W 1206	
R46	20726	RES CMS 150 1% 0.25W 1206	
R47	20726	RES CMS 150 1% 0.25W 1206	
R48	20726	RES CMS 150 1% 0.25W 1206	
R5	20726	RES CMS 150 1% 0.25W 1206	
R6	20724	RES CMS 100 1% 0.25W 1206	
R7	20722	RES CMS 82.5 1% 0.25W 1206	
R8	20765	RES CMS 51.1 1% 0.25W 1206	
R9	20765	RES CMS 51.1 1% 0.25W 1206	
SW1	56425	IC 630/SA630 S08	
TR1	56414	TRSFO 1/1 5-1000MHZ CMS DIP6	
TR2	56414	TRSFO 1/1 5-1000MHZ CMS DIP6	
TR3	56414	TRSFO 1/1 5-1000MHZ CMS DIP6	
TR4	56414	TRSFO 1/1 5-1000MHZ CMS DIP6	
+-----+			

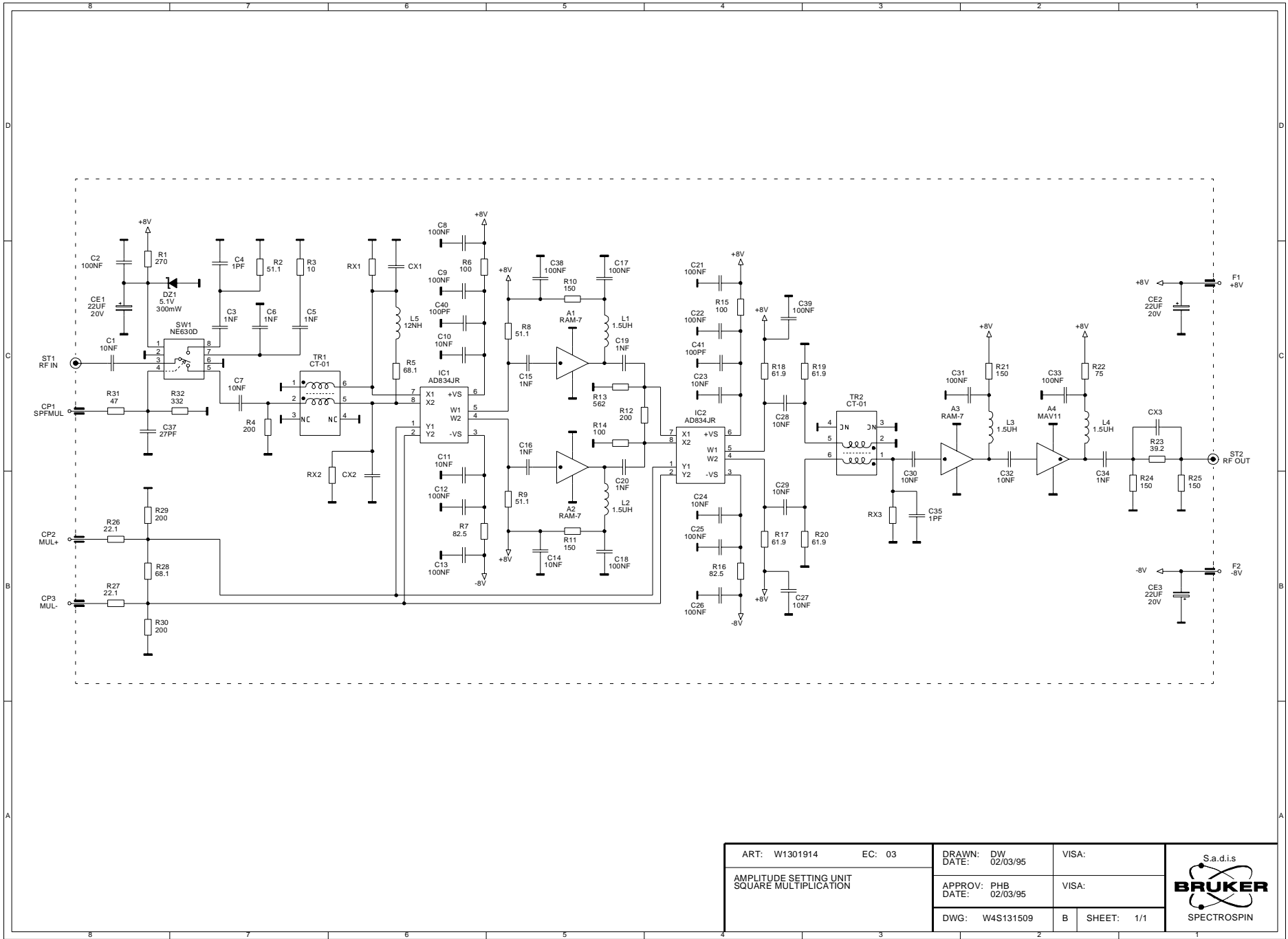
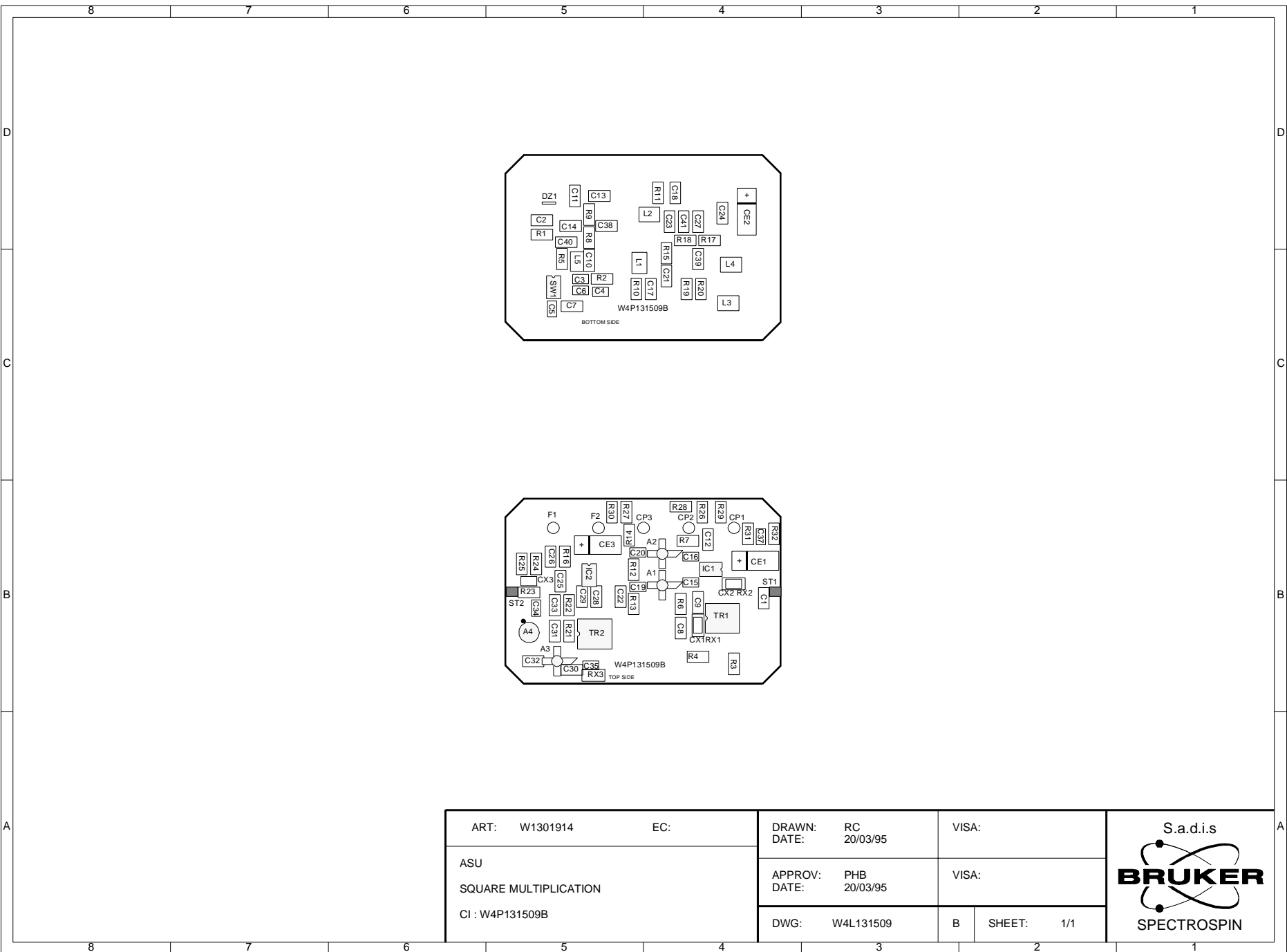
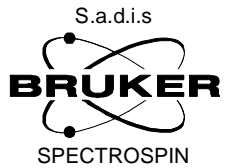

Figure 3.4. Multiplication Schematic

ART: W1301914	EC: 03	DRAWN: DW DATE: 02/03/95	VISA:	
AMPLITUDE SETTING UNIT SQUARE MULTIPLICATION		APPROV: PHB DATE: 02/03/95	VISA:	
		DWG: W4S131509	B SHEET: 1/1	

Figure 3.5. Multiplication Location



ART: W1301914	EC:	DRAWN: RC	VISA:	
ASU		DATE: 20/03/95		
SQUARE MULTIPLICATION		APPROV: PHB	VISA:	
CI : W4P131509B		DATE: 20/03/95		
		DWG: W4L131509	B	SHEET: 1/1

Value Table

Value Tab Head			
Part:W1301914 Drawing:W4S131509B		Copy In Part:	Draw:
Desc:ASU MULTIPLICATION AU CARRE		ECL:0 Modified:02/03/95	By:DEHF
Value Tab			
Pos.	Component	Local Description	
A1	56535	IC 7/HF RAM-7 13DB EQU.MSA0735	
A2	56535	IC 7/HF RAM-7 13DB EQU.MSA0735	
A3	56535	IC 7/HF RAM-7 13DB EQU.MSA0735	
A4	31201	IC 11/HF MAV-11	
C1	21014	COND CMS 1206 10N 50V 20% X7R	
C2	8493	COND CMS 1206 100N 50V 20% X7R	
C3	73183	COND CMS CDR12 1N 150V 20%	
C4	73410	COND CMS CDR12 1P 150V 0.25P	
C5	73183	COND CMS CDR12 1N 150V 20%	
C6	73183	COND CMS CDR12 1N 150V 20%	
C7	21014	COND CMS 1206 10N 50V 20% X7R	
C8	8493	COND CMS 1206 100N 50V 20% X7R	
C9	8493	COND CMS 1206 100N 50V 20% X7R	
C10	21014	COND CMS 1206 10N 50V 20% X7R	
C11	21014	COND CMS 1206 10N 50V 20% X7R	
C12	8493	COND CMS 1206 100N 50V 20% X7R	
C13	8493	COND CMS 1206 100N 50V 20% X7R	
C14	21014	COND CMS 1206 10N 50V 20% X7R	
C15	73183	COND CMS CDR12 1N 150V 20%	
C16	73183	COND CMS CDR12 1N 150V 20%	
C17	8493	COND CMS 1206 100N 50V 20% X7R	
C18	8493	COND CMS 1206 100N 50V 20% X7R	
C19	73183	COND CMS CDR12 1N 150V 20%	
C20	73183	COND CMS CDR12 1N 150V 20%	
C21	8493	COND CMS 1206 100N 50V 20% X7R	
C22	8493	COND CMS 1206 100N 50V 20% X7R	
C23	21014	COND CMS 1206 10N 50V 20% X7R	
C24	21014	COND CMS 1206 10N 50V 20% X7R	
C25	8493	COND CMS 1206 100N 50V 20% X7R	
C26	8493	COND CMS 1206 100N 50V 20% X7R	
C27	21014	COND CMS 1206 10N 50V 20% X7R	
C28	21014	COND CMS 1206 10N 50V 20% X7R	
C29	21014	COND CMS 1206 10N 50V 20% X7R	
C30	21014	COND CMS 1206 10N 50V 20% X7R	
C31	8493	COND CMS 1206 100N 50V 20% X7R	
C32	21014	COND CMS 1206 10N 50V 20% X7R	
C33	8493	COND CMS 1206 100N 50V 20% X7R	
C34	73183	COND CMS CDR12 1N 150V 20%	
C35	73410	COND CMS CDR12 1P 150V 0.25P	
C37	73182	COND CMS CDR12 27P 150V 20%	
C38	8493	COND CMS 1206 100N 50V 20% X7R	
C39	8493	COND CMS 1206 100N 50V 20% X7R	
C40	20990	COND CMS 1206 100P 50V 5% NPO	
C41	20990	COND CMS 1206 100P 50V 5% NPO	
CE1	51557	COND CMS TANTAL 22U 20V 20%	
CE2	51557	COND CMS TANTAL 22U 20V 20%	
CE3	51557	COND CMS TANTAL 22U 20V 20%	
CI1	W1356519	CI MULTIPLICATION AU CARRE	
CP1	59995	ACCBL PICOT FOURCHE D1.1MM	
CP2	59995	ACCBL PICOT FOURCHE D1.1MM	
CP3	59995	ACCBL PICOT FOURCHE D1.1MM	
DZ1	22577	DIODE Z BZX84C 5V1 300MW SOT23	
F1	59995	ACCBL PICOT FOURCHE D1.1MM	
F2	59995	ACCBL PICOT FOURCHE D1.1MM	

Value Tab Head		
Part:W1301914	Drawing:W4S131509B	Copy In Part:
Desc:ASU MULTIPLICATION AU CARRE	ECL:0	Modified:02/03/95
		Draw: By:DEHF
Pos.	Component	Local Description
IC1	56510	IC 834/PAD AD834MULT 0.5GHZSO8
IC2	56510	IC 834/PAD AD834MULT 0.5GHZSO8
L1	22874	SELF CMS 1008 1.5UH 10%
L2	22874	SELF CMS 1008 1.5UH 10%
L3	22874	SELF CMS 1008 1.5UH 10%
L4	22874	SELF CMS 1008 1.5UH 10%
L5	42179	SELF CMS 1008 12NH 20%
R1	53689	RES CMS 274 1% 0.25W 1206
R2	20765	RES CMS 51.1 1% 0.25W 1206
R3	20711	RES CMS 10 1% 0.25W 1206
R4	8854	RES CMS 200 1% 0.25W 1206
R5	20721	RES CMS 68.1 1% 0.25W 1206
R6	20724	RES CMS 100 1% 0.25W 1206
R7	20722	RES CMS 82.5 1% 0.25W 1206
R8	20765	RES CMS 51.1 1% 0.25W 1206
R9	20765	RES CMS 51.1 1% 0.25W 1206
R10	20726	RES CMS 150 1% 0.25W 1206
R11	20726	RES CMS 150 1% 0.25W 1206
R12	8854	RES CMS 200 1% 0.25W 1206
R13	20733	RES CMS 562 1% 0.25W 1206
R14	20724	RES CMS 100 1% 0.25W 1206
R15	20724	RES CMS 100 1% 0.25W 1206
R16	20722	RES CMS 82.5 1% 0.25W 1206
R17	8853	RES CMS 61.9 1% 0.25W 1206
R18	8853	RES CMS 61.9 1% 0.25W 1206
R19	8853	RES CMS 61.9 1% 0.25W 1206
R20	8853	RES CMS 61.9 1% 0.25W 1206
R21	20726	RES CMS 150 1% 0.25W 1206
R22	51836	RES CMS 75 1% 0.25W 1206
R23	20718	RES CMS 39.2 1% 0.25W 1206
R24	20726	RES CMS 150 1% 0.25W 1206
R25	20726	RES CMS 150 1% 0.25W 1206
R26	20715	RES CMS 22.1 1% 0.25W 1206
R27	20715	RES CMS 22.1 1% 0.25W 1206
R28	20721	RES CMS 68.1 1% 0.25W 1206
R29	8854	RES CMS 200 1% 0.25W 1206
R30	8854	RES CMS 200 1% 0.25W 1206
R31	73283	RES CMS 47.5 1% 0.25W 1206
R32	20730	RES CMS 332 1% 0.25W 1206
SW1	56425	IC 630/SA630 S08
TR1	56414	TRSFO 1/1 5-1000MHZ CMS DIP6
TR2	56414	TRSFO 1/1 5-1000MHZ CMS DIP6

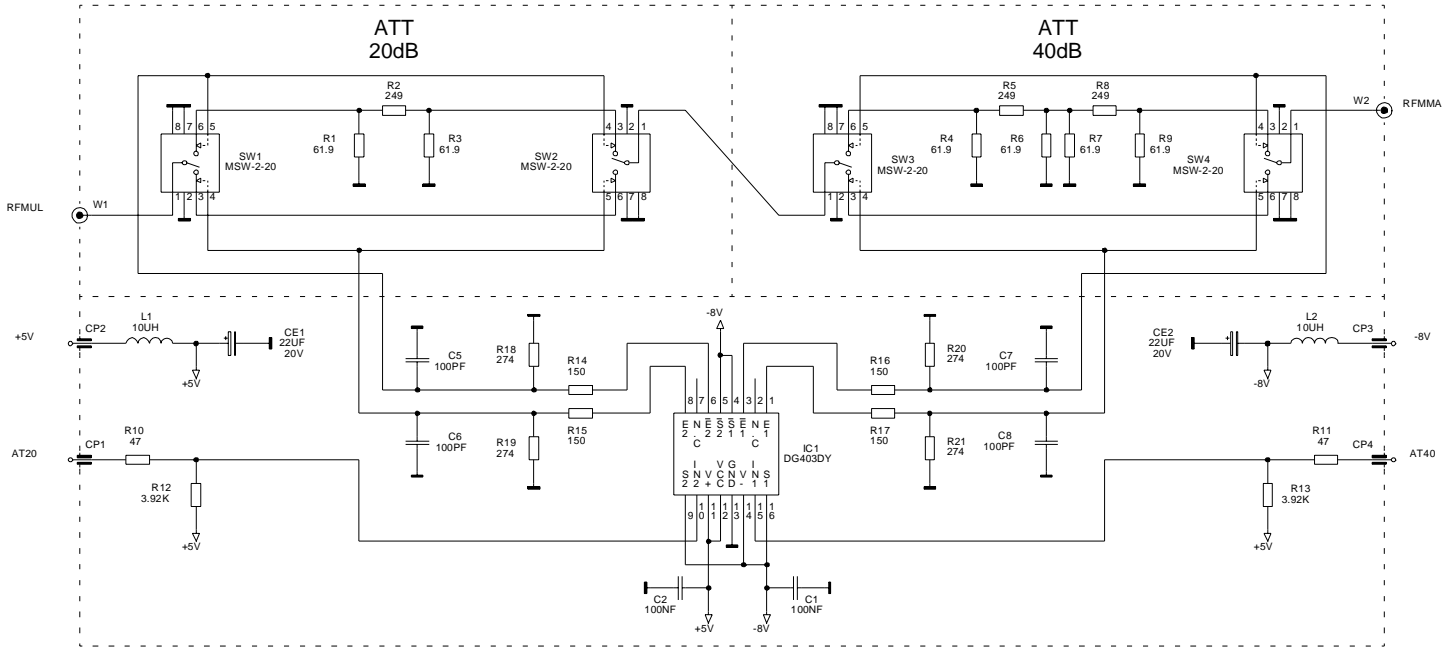
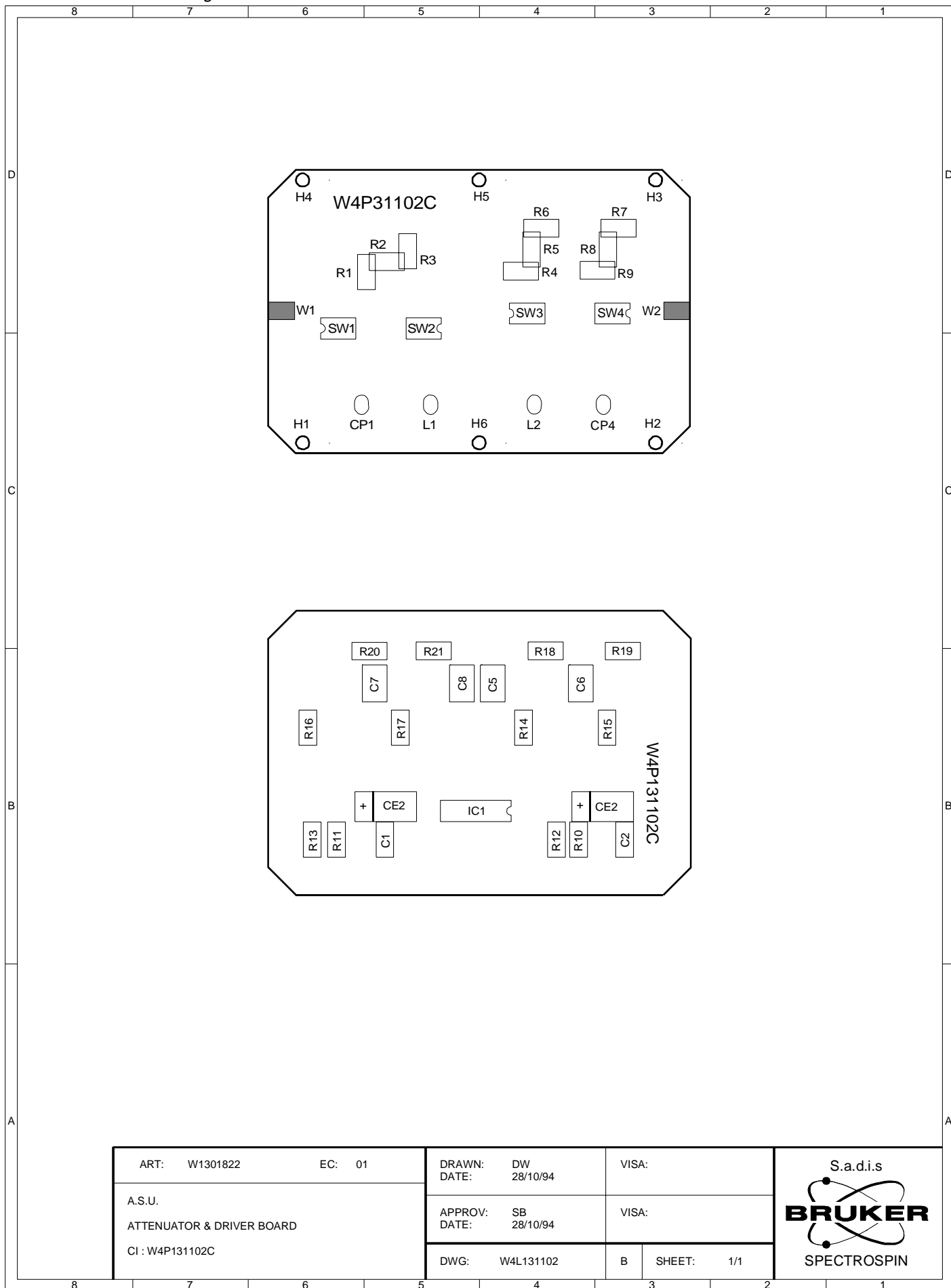

Figure 3.6. Attenuator Schematic

ART: W1301948	EC: 01	DRAWN: DW DATE: 26/09/94	VISA:
AMPLITUDE SETTING UNIT ATTENUATOR & DRIVER BOARD		APPROV: SB DATE: 26/09/94	VISA:
		DWG: W4S132081	SHEET: 1/1



Figure 3.7. Attenuator Location

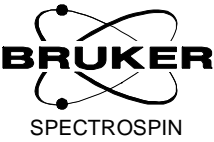

ART: W1301822	EC: 01	DRAWN: DW	DATE: 28/10/94	VISA:
A.S.U.		APPROV: SB	DATE: 28/10/94	VISA:
ATTENUATOR & DRIVER BOARD		DWG: W4L131102	B	SHEET: 1/1
CI : W4P131102C		S.a.d.i.s  SPECTROSPIN		

Value Table

Value Tab Head			
Part:W1301948 Drawing:W4S132081		Copy In Part:	Draw:
Desc:ASU ATTENUATEUR & PILOTE		ECL:0	Modified:27/10/97 By:MN
Value Tab			
Pos.	Component	Local Description	
C1	8493	COND CMS 1206 100N 50V 20% X7R	
C2	8493	COND CMS 1206 100N 50V 20% X7R	
C5	30412	COND CMS CDR14 100P 500V 20%	
C6	30412	COND CMS CDR14 100P 500V 20%	
C7	30412	COND CMS CDR14 100P 500V 20%	
C8	30412	COND CMS CDR14 100P 500V 20%	
CE1	51557	COND CMS TANTAL 22U 20V 20%	
CE2	51557	COND CMS TANTAL 22U 20V 20%	
CI1	W1356233	CI ASU ATTENUATOR & DRIVER	
CP1	59995	ACCBL PICOT FOURCHE D1.1MM	
CP4	59995	ACCBL PICOT FOURCHE D1.1MM	
IC1	22554	IC 403/SWI DG403DY SO16	
L1	30155	SELF 10UH 0.14A	
L2	30155	SELF 10UH 0.14A	
R1	8853	RES CMS 61.9 1% 0.25W 1206	
R2	56314	RES CMS 249 1% 0.25W 1206	
R3	8853	RES CMS 61.9 1% 0.25W 1206	
R4	8853	RES CMS 61.9 1% 0.25W 1206	
R5	56314	RES CMS 249 1% 0.25W 1206	
R6	8853	RES CMS 61.9 1% 0.25W 1206	
R7	8853	RES CMS 61.9 1% 0.25W 1206	
R8	56314	RES CMS 249 1% 0.25W 1206	
R9	8853	RES CMS 61.9 1% 0.25W 1206	
R10	73283	RES CMS 47.5 1% 0.25W 1206	
R11	73283	RES CMS 47.5 1% 0.25W 1206	
R12	20744	RES CMS 3.92K 1% 0.25W 1206	
R13	20744	RES CMS 3.92K 1% 0.25W 1206	
R14	20726	RES CMS 150 1% 0.25W 1206	
R15	20726	RES CMS 150 1% 0.25W 1206	
R16	20726	RES CMS 150 1% 0.25W 1206	
R17	20726	RES CMS 150 1% 0.25W 1206	
R18	53689	RES CMS 274 1% 0.25W 1206	
R19	53689	RES CMS 274 1% 0.25W 1206	
R20	53689	RES CMS 274 1% 0.25W 1206	
R21	53689	RES CMS 274 1% 0.25W 1206	
SW1	56407	SW ASGA CMS DC-1GHZ	
SW2	56407	SW ASGA CMS DC-1GHZ	
SW3	56407	SW ASGA CMS DC-1GHZ	
SW4	56407	SW ASGA CMS DC-1GHZ	

Specifications

4

Characteristics of Amplitude Setting Unit Single Channel

4.1

The specifications below fit with the last upgrading of the unit. (February 1997)

RF specifications

4.1.1

Frequency range	5 to 850 MHz
Gain	1 dB \pm 1 dB
Input power	4 dBm \pm 0,5 dB
Output power	5 dBm \pm 1 dB for 4 dBm IN
Input VSWR	1.4
Output VSWR	1.5
Power out 1 dB Compression	5 dBm
Output harmonics H2	- 30 dBm
Output harmonics H3	- 30 dBm

Amplitude control

4.1.2

	from 0 to +1V/-1V 100 Ω balanced load (MOD & MULT)
	Cubical law for Modulation
	Square law for Multiplication
	Digital input for 20dB & 40dB Attenuation
	(1 : through - 0 : active)
SPF & BLK	(0 : through - 1 : blanked)

Safety switch

4.1.3

SPENAB digital input (1 : RF Off)
(0 : RF On)

Specifications

Dynamics

4.1.4

Dynamic range	120 dB
Modulation dynamic	50 dB (50dB @ 600 MHz) -40 dB (50dB* @ 800 MHz)
Multiplication dynamic	40 dB (50dB @ 600 MHz) -30 dB (40dB* @ 800 MHz) (* = ± 2dB linearity)
Attenuators	20 dB (± 1dB) + 40 dB (± 1dB) @ 800 MHz

Phase shift

4.1.5

Modulation @ 50 dB Range (25°C)	<15° for 600 MHz <25° for 800 MHz
Multiplication @ 30 dB	<10° for 600 MHz <15° for 800 MHz
Typical thermal stability (25°C to 50°C)	$\frac{\Delta\phi}{\Delta T} = -F \times 3.10^{-3} \text{ degree.K}^{-1}$ (example : F = 800 MHz, T from 300 to 315k ⇒ Δφ = -36°)

Isolation (SPENAB CMD), (MOD & MULT at max. level)

4.1.6

Isolation input / output	70 dB
Isolation input / output + ATT : 60 dB	110 dB

Output noise level

4.1.7

Unblanked (MOD, MULT = 0V)	< -135 dBm (1 Hz)
Unblanked (MOD, MULT = 2.5V)	< -124 dBm (1 Hz)
Blanked (ATT = 60 dB, SPF = 0V)	Thermal noise

Switching time

4.1.8

Rise Time	200 ns
DC Ringing	150 mV
Fall Time	100 ns
DC Ringing	10 mV
Propagation Time	40 ns

DC requirements

4.1.9

Supply +15V	420 mA
Supply -15V	200 mA
Supply +5V	100 mA

Characteristics of Amplitude Setting Unit Single Channel

Operating temperature

4.1.10

Ambiance temperature range

+20°C @ +40°C

Figures

1	ASU Single Channel	7
Figure 1.1.	Amplitude Setting Unit Single Channel Location	8
Figure 1.2.	Amplitude Setting Unit Single Channel Block Diagram	9
Figure 1.3.	Amplitude Setting Unit Single Channel Wiring Diagram	10
2	Interface	11
Figure 2.1.	Interface Schematic	12
Figure 2.2.	Interface Location	13
Figure 2.3.	PAL ASU03/01 Logical Program	14
3	MMA Unit	19
Figure 3.1.	Modulation, Multiplication & Attenuator Block Diagram	20
Figure 3.2.	Modulation Schematic	21
Figure 3.3.	Modulation Location	22
Figure 3.4.	Multiplication Schematic	26
Figure 3.5.	Multiplication Location	27
Figure 3.6.	Attenuator Schematic	30
Figure 3.7.	Attenuator Location	31
4	Specifications	33

Tables

1	ASU Single Channel	7
2	Interface	11
Table 2.1.	Front Panel Connector J1	17
Table 2.2.	Rear Panel Connector J2	18
3	MMA Unit	19
4	Specifications	33

