

# **Variable Temperature Unit**

**Technical Manual  
BVT3200**

**Version 001**

---

**BRUKER SA**

---

The information in this manual may be altered without notice.

BRUKER SA accepts no responsibility for actions taken as a result of use of this manual. BRUKER SA accepts no liability for any mistakes contained in the manual, leading to coincidental damage, whether during installation or operation of the instrument. Unauthorised reproduction of manual contents, without written permission from the publishers, or translation into another language, either in full or in part, is forbidden.

This manual was written by

P. KRENCKER and D. PODADERA

© octobre 21, 1999: Bruker SA

Wissembourg, France

Manual P/N: Z31544

DWG-Nr: 1251/001

# Contents

	<b>Contents .....</b>	<b>3</b>
	<b>Index .....</b>	<b>5</b>
<b>1</b>	<b>Description .....</b>	<b>7</b>
1.1	Introduction .....	7
1.2	BVT3200 main components .....	9
1.3	Parts location .....	9
1.4	Principle of operation .....	9
1.5	The front panel .....	11
1.6	Gas flow circuit .....	13
	Setting up the gas flow .....	14
1.7	Front panel connectors .....	15
	Heater connector .....	15
	Pt100 connector .....	16
	Thermocouple connector .....	17
	RS232 connector .....	18
	N <sub>2</sub> connector (option) .....	19
	BCU05 connector .....	19
	BVTB 3500 connector .....	20
<b>2</b>	<b>Options .....</b>	<b>21</b>
2.1	Low temperature options .....	21
2.2	LN <sub>2</sub> exchanger .....	22
	Exchanger presentation .....	22
	Exchanger installation .....	23
2.3	LN <sub>2</sub> evaporator .....	24
	Evaporator presentation .....	25
	Evaporator installation .....	26
2.4	BCU05 gas cooler .....	28
<b>3</b>	<b>Configuration .....</b>	<b>29</b>
3.1	Sensor selection .....	29
3.2	Eurotherm 2416 configuration .....	29
<b>4</b>	<b>Remote interface control .....</b>	<b>31</b>
4.1	Microcontroller interface .....	31
4.2	Digital interface specifications .....	31
4.3	Commands and communication protocol .....	32
4.4	Control characters .....	32
4.5	List of commands .....	33
4.6	Rs232 link characteristics .....	34

4.7	Rs232 cable .....	34
4.8	Authorised functions .....	34
	AF (Air flow) .....	36
	CM (Check memory for test only) .....	37
	CO (Communications speed) .....	38
	DL (Download) .....	39
	DT (DAC check for test only) .....	40
	ES (Error status) .....	41
	HP (Heater power) .....	42
	IS (Interface status) .....	43
	NH (Nitrogen heater) .....	44
	NP (Nitrogen heater power) .....	45
	P1 (Port 1 for test only) .....	46
	P2 (Port 2 for test only) .....	47
	P3 (Port 3 for test only) .....	48
	P4 (Port 4 for test only) .....	49
	RB (Read BBIS) .....	50
	SV (Software version) .....	51
	WB (Write BBIS) .....	52
	WR (Write record) .....	53
	XR (Extract a record) .....	54
<b>5</b>	<b>Technical specifications.....</b>	<b>55</b>
5.1	Specifications .....	55
5.2	Safety fuses .....	56
	<b>Figures .....</b>	<b>59</b>
	<b>Tables .....</b>	<b>61</b>

# Index

## **B**

BBIS eeprom.....	32
BCU05 connector.....	19
BCU05 gas cooler.....	21, 28
BTO2000.....	16, 29
BVTB 3500 connector.....	20

## **D**

digital interface specification.....	31
--------------------------------------	----

## **F**

front panel connectors.....	15
fuses.....	56

## **G**

Gas flow indicator.....	12
-------------------------	----

## **H**

Heater connector.....	15
-----------------------	----

## **L**

LN <sub>2</sub> evaporator.....	19, 21
LN <sub>2</sub> exchanger.....	19
Low temperature.....	21

## **N**

N <sub>2</sub> connector.....	19
-------------------------------	----

## **P**

Pt100 connector.....	16
----------------------	----

## **R**

remote interface control.....	31
RS232 connector.....	18

**S**

Sensor selection..... 29

**T**

Temperature controller ..... 7  
Thermocouple connector ..... 17  
thermocouple T ..... 9

# *Description*

# 1

## *Introduction*

## 1.1

The new BVT3200 is small size variable temperature unit on single double europe size board.

It has microcontroller interface for remote control by the host computer.

The unit includes:

- A temperature controller (EUROTHERM model 2416).
- The microcontroller and its electronics and the power electronics for the probe heater.
- A gas flow circuitry (pressure regulator and a block of four valves for gas flow control).

The unit is ready to receive an option board for low temperature - LN<sub>2</sub> evaporator or heat exchanger - .

The BVT3200 is supplied by the general power supply of the BSMS/2 crate. The power stage is supplied by an additional 48 V power supply board.

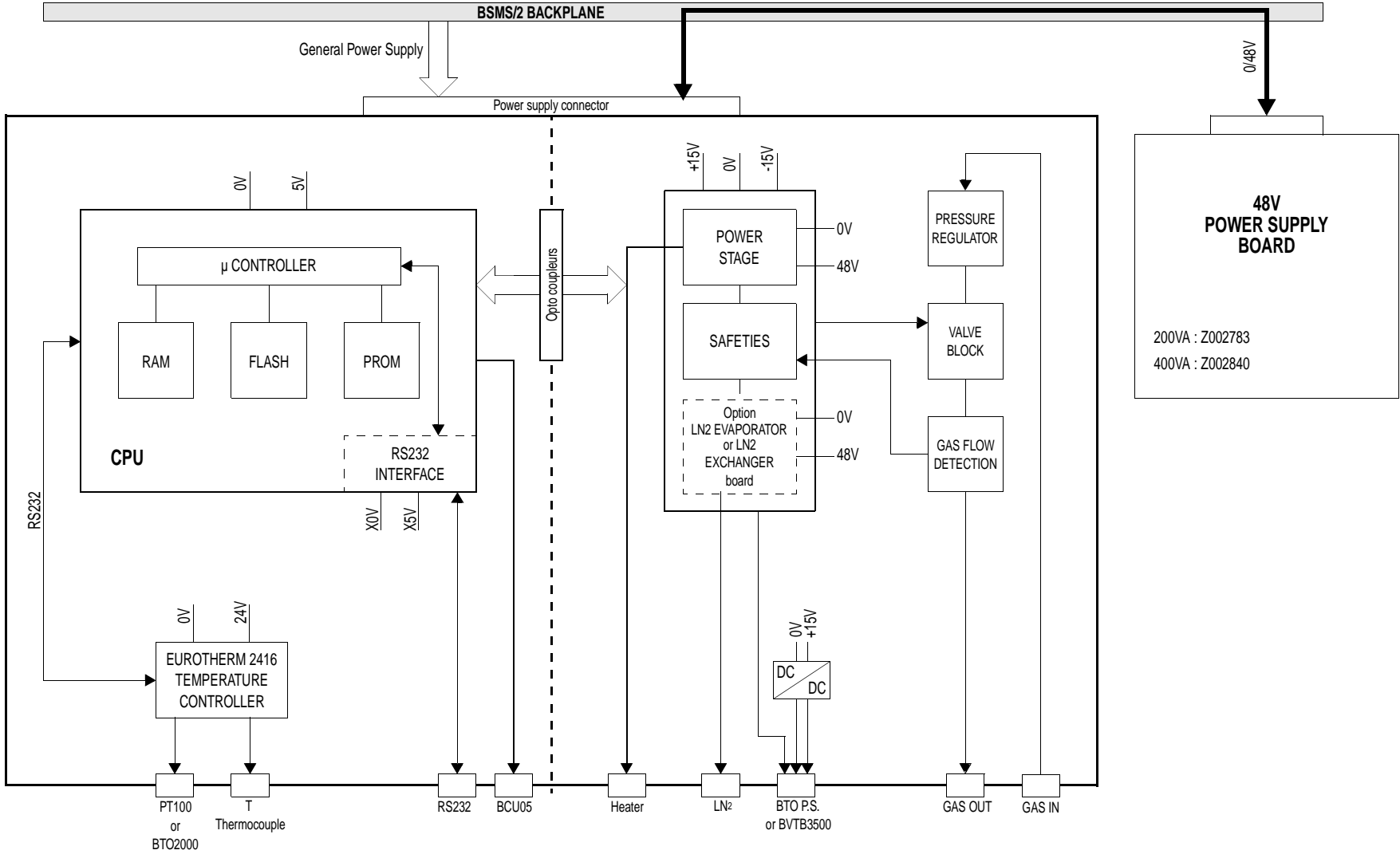


Figure 1.1. BVT3200 block diagram



## BVT3200 main components

1.2

The interface board has a microcontroller for remote control of the BVT3200. Two RS232 ports are available on this printed circuit. One port, on the front panel side, is for the communication with host computer and the other for communication with the Eurotherm 2416 temperature controller.

The power supply connector is at the rear side of the board. On the front, a gas flow indicator with a steel ball detects the gas flow. A device, called valve block, is a group of four valves which control the gas flow rate.

## Parts location

1.3

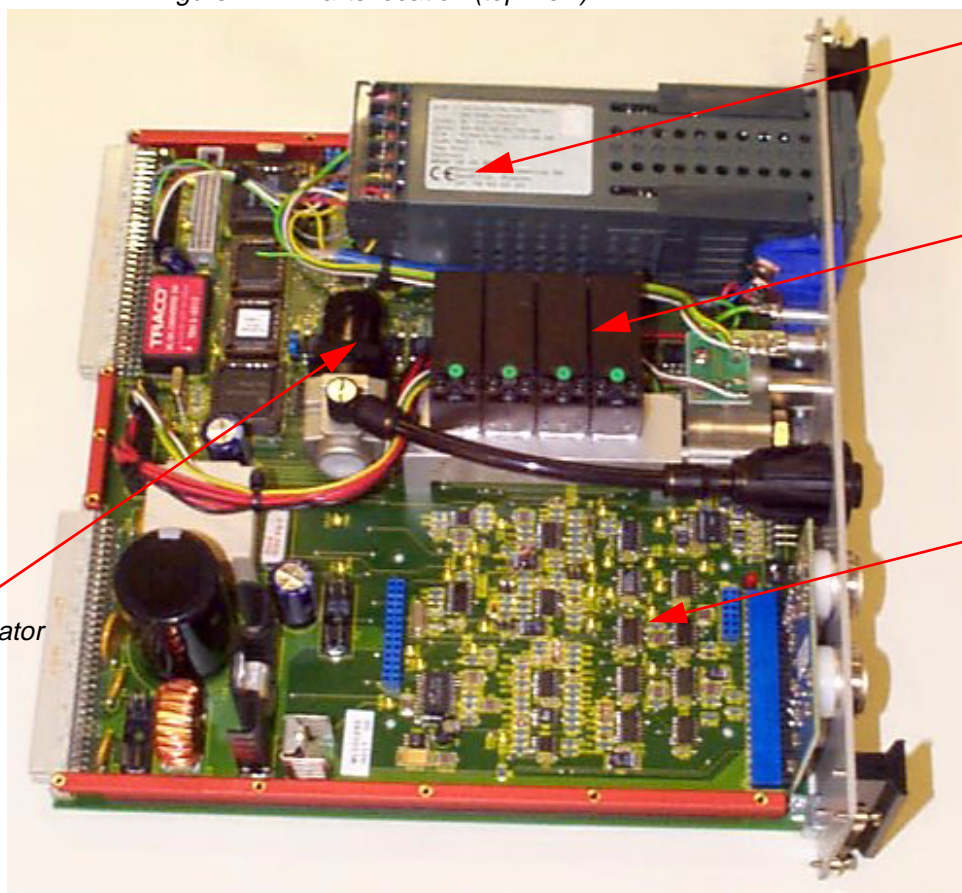
Figure 1.2. Parts location (top view)

Eurotherm controller

Valve block

location of low temperature option board

Pressure regulator



## Principle of operation

1.4

The sample tube located in the magnet is heated by a constant gas flow delivered by the BVT3200. A temperature sensor (e.g. a thermocouple T) under the sample tube measures the gas temperature and the temperature controller compares the actual temperature to the target temperature programmed by the operator. It controls the power applied to the heater placed at the base of the magnet in order to

## Description

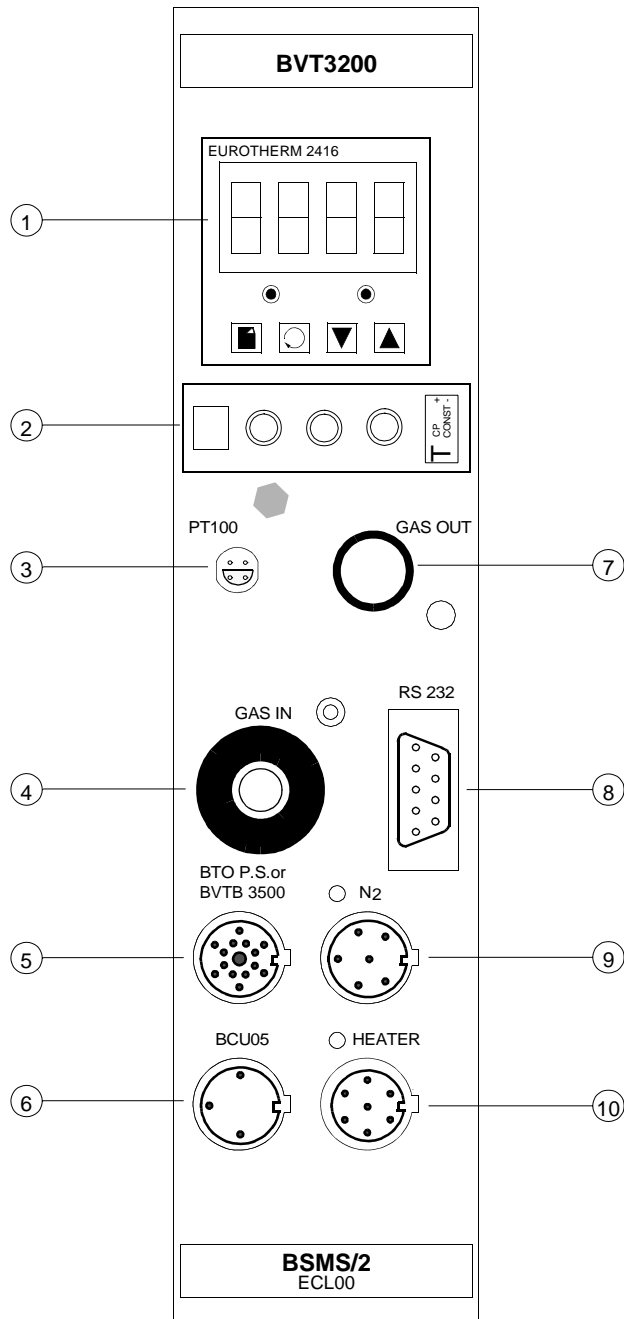
stabilise the gas temperature. A special gas flow switch monitors continuously the gas flow in the BVT3200 and switches off the probe heater when the gas flow is missing. A safety thermocouple measures also the heater temperature and avoids probe overheating in case of missing gas flow in the probe.

Front panel description :

- 1: Eurotherm 2416 controller
- 2: Thermocouple connector type T
- 3: PT100 connector or BTO2000
- 4: Gas IN
- 5: BT02000 power supply or BVTB3500
- 6: BCU05 connector
- 7: Gas OUT
- 8: RS232 connector
- 9: N<sub>2</sub> connector
- 10: Heater connector

# Description

Figure 1.3. BVT3200 front panel



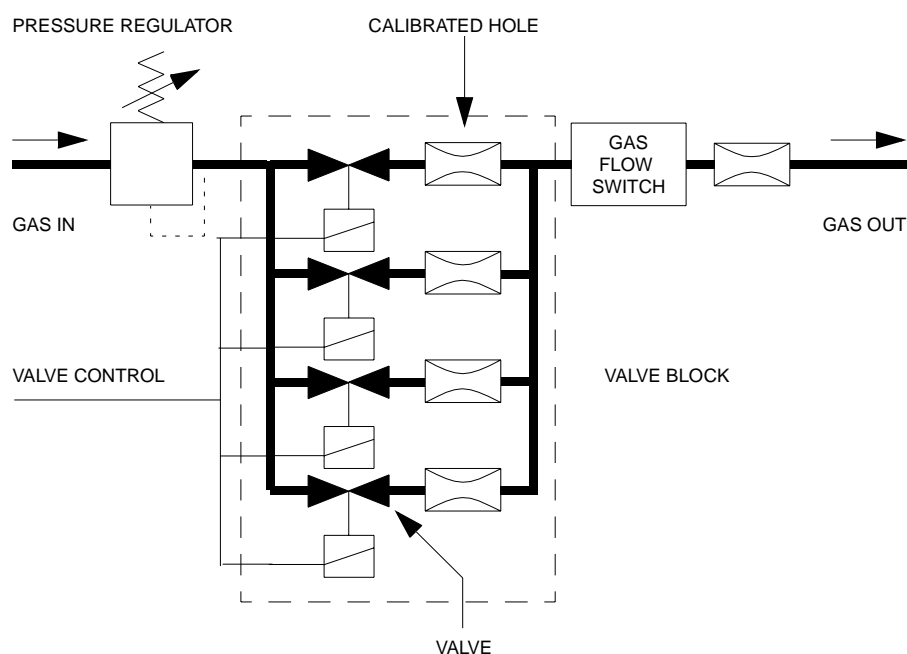
On the middle of the PC (printed circuit) a pressure regulator delivers gas at constant pressure to a group of valves. Each valve, when open, let the gas flow through a calibrated hole. As all valves are in parallel, it is possible to obtain 15 different gas flow rates.

The regulator is factory adjusted to obtain approximately 2000 l/h when all valves are open.

The default value at power on can be changed by hardware jumpers (JP6 to JP9) see figure ***"Valve jumpers settings" on page 49.***

On the front panel a gas flow meter with a steel ball indicates the actual gas flow. An optical barrier at the bottom detects a missing gas flow.

Figure 1.4. Gas flow circuit



Connect the BVT3200 gas input to a dry air or N<sub>2</sub> gas supply line. The input pressure should be at least 4 Bar and must not exceed 7.5 Bar. Power on the BVT3200. The default value of the flow rate is set according to the position of jumper JP7 to JP10 (see AF command [page 36](#)). The gas flow rate can also be changed by software in the «EDTE» program on NMR spectrometer.

Table 1.1. Gas flow rate versus command

DECIMAL COMBINATION	COMBINATION ABCD	FLOW RATE (L/H)
0	0000	0
1	0001	135
2	0010	270
3	0011	400
4	0100	535
5	0101	670
6	0110	800
7	0111	935
8	1000	1070
9	1001	1200
10	1010	1335
11	1011	1470
12	1100	1600
13	1101	1735
14	1110	1870
15	1111	2000

## Front panel connectors

1.7

### Heater connector

1.7.1

The heater cable is plugged in this connector. A safety thermocouple is located close to the heater resistance in order to detect an overheating in case of a missing gas flow for example.

Figure 1.5. Heater connector (Front view)

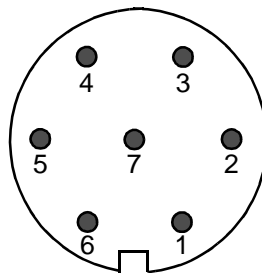


Table 1.2. Heater connector pin assignment

PIN	SIGNAL
1	heater +
2	heater +
3	safety thermocouple +
4	safety thermocouple -
5	heater -
6	heater -
7	gnd

Figure 1.6. Pt100 connector (front view)

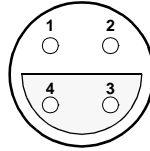


Table 1.3. Pt100 connector pin assignment

PIN	SIGNAL
1	current +
2	measure
3	measure
4	current -

⇒ **Note.** This connector is also used to connect the BTO2000. Pin 2 and 3 are used as signal input pins.



Figure 1.7. Thermocouple connector (Front view)

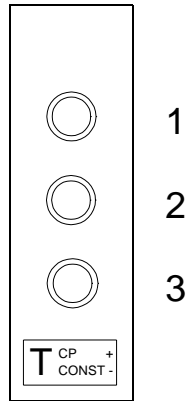


Table 1.4. Thermocouple T pin assignment

PIN	SIGNAL
1	(Cu) Shield
2	(Cu) Thermocouple +
3	(Co) Thermocouple -

Figure 1.8. RS232 male connector (Front view)

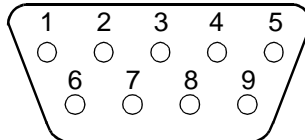


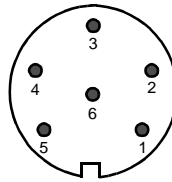
Table 1.5. RS232 connector pin assignment

PIN	SIGNAL
1	NC
2	RxD
3	TxD
4	NC
5	GND
6	NC
7	RTS
8	DTR
9	NC

***N<sub>2</sub> connector (option)***

**1.7.5**

*Figure 1.9. N<sub>2</sub> connector (Front view)*



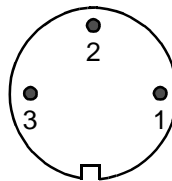
*Table 1.6. Evaporator connector pin assignment*

PIN NUMBER	SIGNAL NAME	COMMENT
1	heater +	power output (0 - 40 vac)
2	level sensor +	level detection input (0 - 2,5 V)
3	evaporator detection	evaporator detected if grounded
4	gnd	ground (0 V)
5	heater -	ground power
6	exchanger detection	exchanger detected if grounded

***BCU05 connector***

**1.7.6**

*Figure 1.10. BCU05 connector*



*Table 1.7. BCU05 connector pin assignment*

PIN NUMBER	SIGNAL NAME	COMMENT
1	heater on (output)	turns on the BCU05 when high (> 2,4 V)
2	dgnd	digital ground
3	nc	not connected

## Description

### BVTB 3500 connector

1.7.7

Figure 1.11. BVTB 3500 connector (Front view)

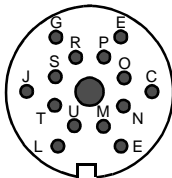


Table 1.8. BVTB 3500 connector pin assignment

PIN	SIGNAL NAME	DIRECTION	COMMENT
A	+5V	O	digital Vcc output
C	NC	---	reserved
E	gnd_BTO	O	BTO2000 has an isolated supply GND
G	+15 v_BTO	O	BTO2000 has an isolated supply output +15V
J	NC	---	reserved
L	dgnd	O	digital ground
M	sda	I/O	I2C bus data line
N	scl	I/O	I2C bus clock line
O	power control	O	0 to 10 volt heater power control output
P	pgnd	O	power ground
R	pgnd	O	power ground
S	thermocouple	I	safety thermocouple input
T	b_relay	O	BVTB 3500 heater relay command
U	b_connected	I	if grounded BVTB 3500 is detected

The BVTB3500 is a power booster for the BVT3200.

For sample temperature control below room temperature one must use cold gas. The BVT3200 can drive several devices for cold gas production :

- LN<sub>2</sub> heat exchanger
- LN<sub>2</sub> evaporator
- BCU05 gas cooler

The nitrogen level in the dewar is monitored by the VTU and the power level applied to the LN<sub>2</sub> heater is computer controlled. For both first options, an additional printed circuit must be installed. The LN<sub>2</sub> heater cable or the exchanger cable is plugged in the N<sub>2</sub> connector on the front plate.

**LN<sub>2</sub> exchanger****2.2**

This device allows to extend sample temperature control below room temperature. A nitrogen gas supply line is required for this device. The N<sub>2</sub> gas is cooled while passing in a heat exchanger tube which soaks in liquid nitrogen. The cold gas is then transferred to the probe by a flexible isolated transfer line.

➡ **The gas flow is stopped (it means all four valves are closed in the BVT3200) whenever the heater power is off, avoiding sample freezing.**

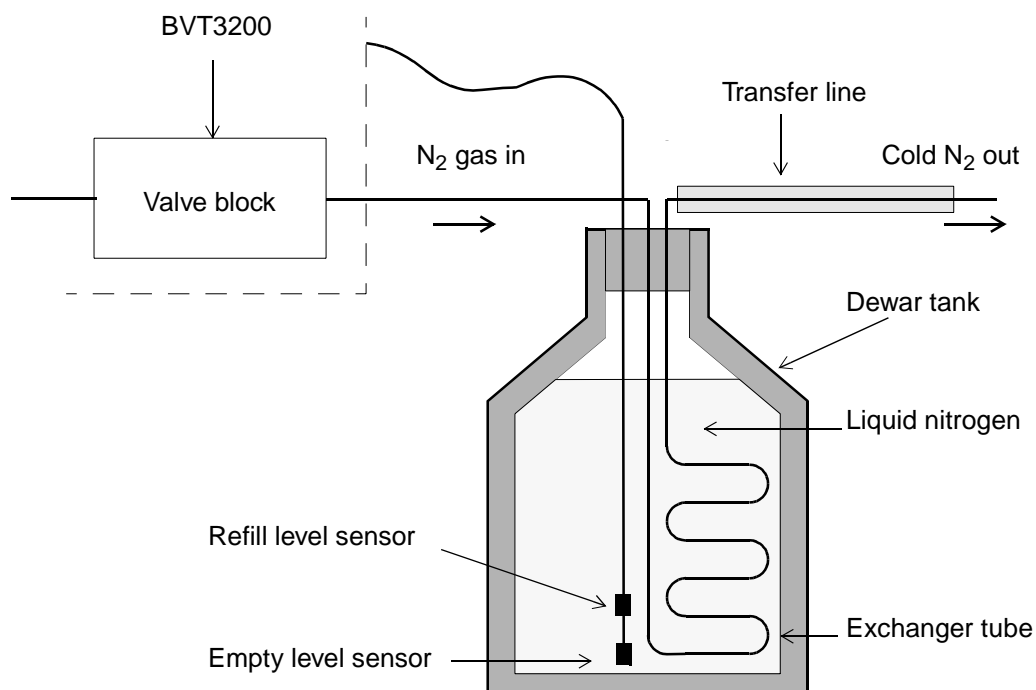
A printed circuit (PC) must be installed in the VT unit.

The printed circuit has the part number W1101296. It is plugged on the printed circuit and fixed by four plastic spacers.

Temperature accuracy is unchanged.

**Exchanger presentation****2.2.1**

Figure 2.1. Exchanger principle



1. Turn off the BSMS/2 power supply
2. Wait 2 minutes to permit the complete discharge of the output capacitor of the heater electronics.
3. Unscrew and remove the BVT3200 from the crate.
4. Disconnect the inlet gas tube (see picture 1 ***page 27***).
5. Hold the printer circuit (W1101296) over the main printed circuit, the big male connector on the bottom side of the printed circuit must face the same size female connector of on the top main printed circuit. The 4 plastic spacers must be pushed carefully in the corresponding holes of the main board until they are locked (see picture 2 ***page 27***)
6. Plug the gas tube as shown in picture 3 (see ***page 27***).
7. Insert the BVT3200 in the BSMS/2 crate.
8. Plug the LN<sub>2</sub> exchanger cable in the N<sub>2</sub> connector and insert the exchanger in the LN<sub>2</sub> dewar.
9. Turn on the power supply of the BSMS/2.

This device is a cold nitrogen gas generator for low temperature experiments. The nitrogen gas is produced by evaporating the liquid nitrogen contained in a dewar. The power delivered to the heater, controlled by software, may reach 210 Watts (approx. 38 V on a 7 ohm heater). The cold gas is transferred to the probe trough a flexible and isolated transfer line.

For this device, an option printed circuit (PC) must be installed in the BVT3200. It delivers the power applied on the LN<sub>2</sub> heater. The LN<sub>2</sub> level in the dewar is continuously monitored by the VTU.

This PC has the part number W1101260. It is plugged on the main board of the BVT3200 and is retained by four plastic spacers.

Temperature accuracy is unchanged.

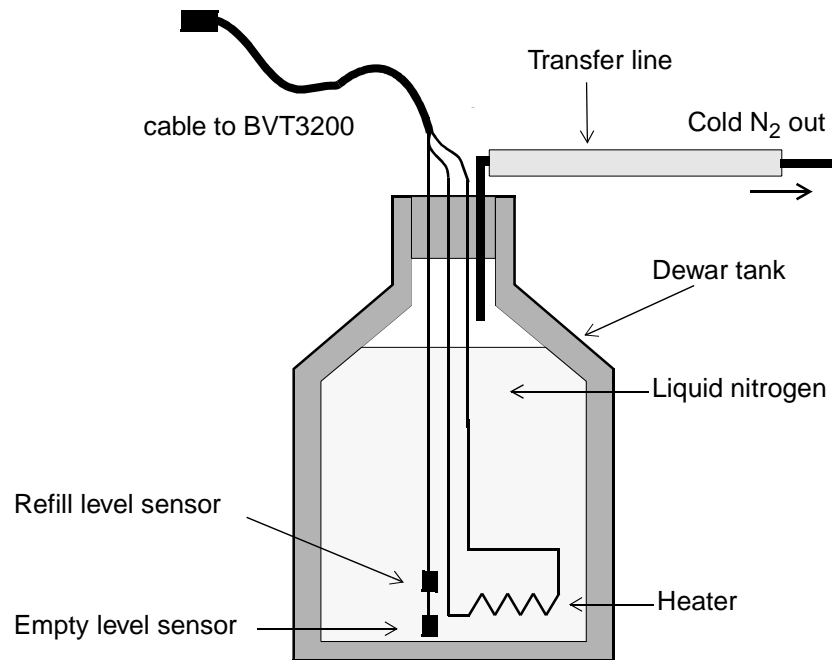


**WARNING**

*The BSMS/2 must be equipped with a 48/400 VA power supply (Z002840) to use the LN<sub>2</sub> evaporator option. When a standard 48/200 VA power supply is present in the rack, the rear side must be unscrewed and removed to replace the power supply located beside the BVT3200.*

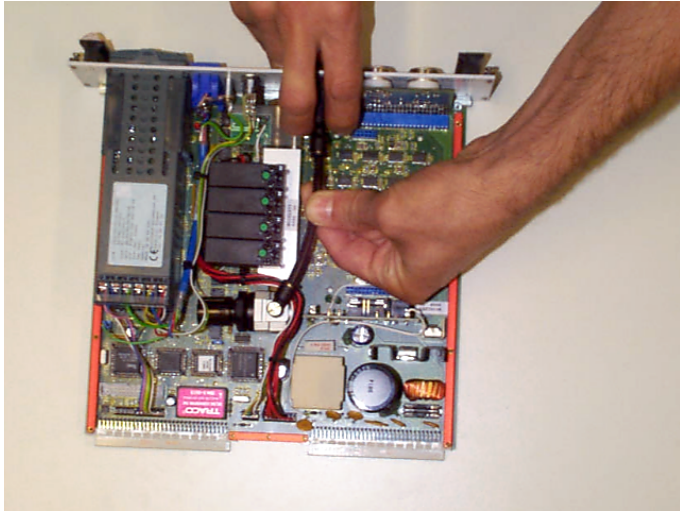


Figure 2.2. Evaporator principle



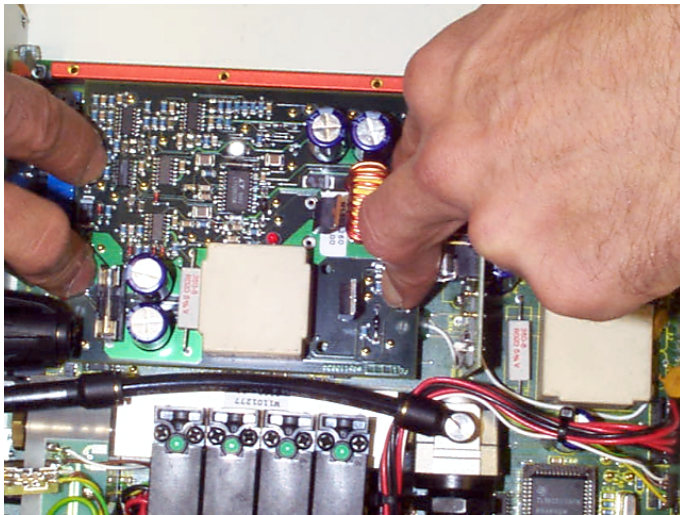
1. Turn off the BSMS/2 power supply.
2. Wait 2 minutes to permit the complete discharge of the output capacitor of the heater electronics.
3. Unscrew and remove the BVT3200 from the crate.
4. Disconnect the inlet gas tube (see picture 1 [page 27](#)).
5. Hold the printer circuit (W1101260) over the main printed circuit, the big male connector on the bottom side of the printed circuit must face the corresponding female connector on the component side of the main printed circuit. The 4 plastic spacers must be pushed carefully in the corresponding holes of the main board until they are locked (see picture 2 [page 27](#)).
6. Plug the gas tube as shown in picture 3 (see [page 27](#)).
7. Insert the BVT3200 in the BSMS/2 crate.
8. Plug the LN<sub>2</sub> evaporator cable in the connector N<sub>2</sub> and insert the evaporator accessory in the LN<sub>2</sub> dewar.
9. Turn on the power supply of the BSMS/2.

Figure 2.3. Option installation



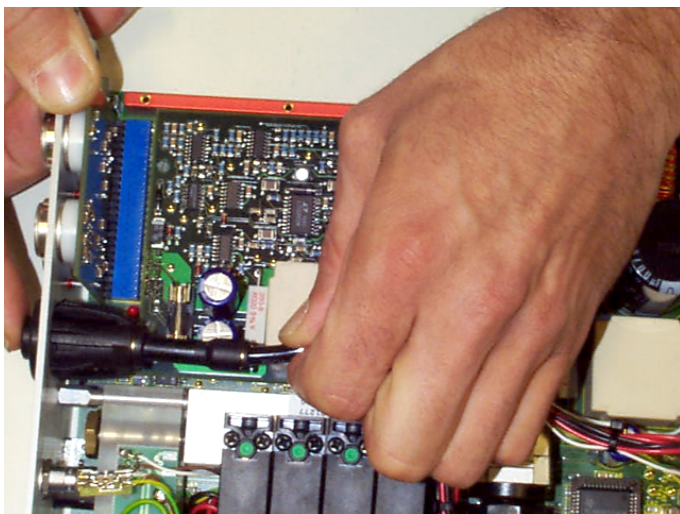
**Picture 1 :**

To dismount the gas tube, push forward the gas connector ring and pull back the tube.



**Picture 2 :**

Press on the option board until the 4 plastic spacers are locked.



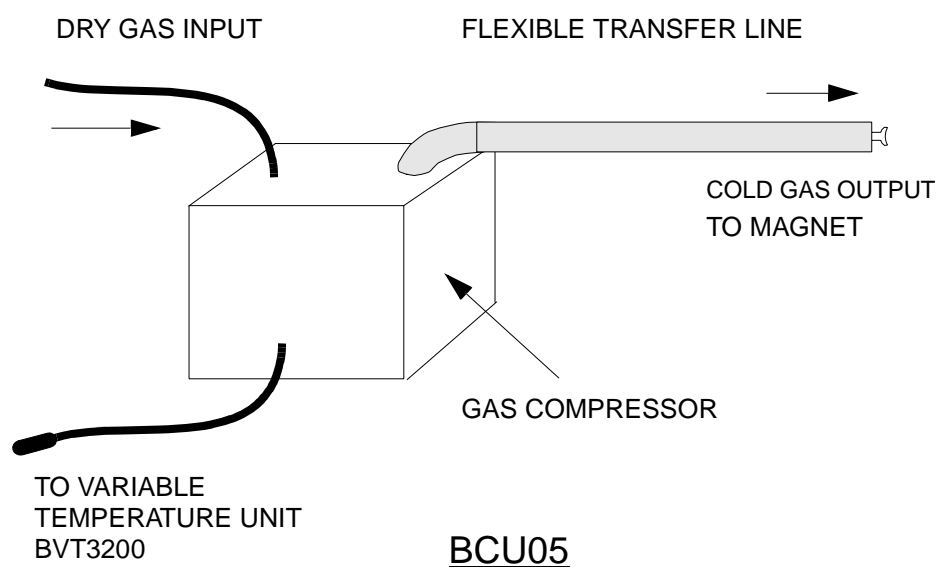
**Picture 3 :**

Push the male gas connector in the female plug.

The BCU05 is a device that cools dry air or nitrogen gas. The device comprises a gas circuit with a gas compressor, an evaporator and a cooler. The nitrogen gas is cooled as it circulates along the evaporator which is located inside the isolated transfer line that connects the BCU05 to the magnet. At the output of the transfer line the gas temperature may reach - 40 °C.

The BCU05 has a cable that must be plugged in the connector marked BCU05. When the probe heater is **ON** a signal is delivered to turn on the compressor of the BCU05. This security avoids freezing of the the sample when the BVT3200 power is off.

Figure 2.4. BCU05 principle



# Configuration

# 3

## **Sensor selection**

**3.1**

The BVT3200 can be used with three types of temperature sensors :

- Thermocouple T (factory set)
- BTO2000 for high stability
- PT100 sensor

⇒ **Warning: Never connect two sensors at a same time on the BVT3200.**

## **Eurotherm 2416 configuration**

**3.2**

The EUROTHERM 2416 controller must be configured to work with the right type of sensor.

The sensor can be selected in the EDTE program, it also can be chosen on the keypad of the temperature controller( see the manual of the 2416 controller).



# Remote interface control

# 4

## Microcontroller interface

## 4.1

This interface has several functions :

- Host computer - EUROTHERM transparent communication through a serial port
- Transmission of BVT3200 internal status to host computer.
- Probe heater on/off control
- Gas flow rate settings.
- Installed option control :
  1. Evaporator heating power settings.
  2. Exchanger control with nitrogen level detection.
- etc.

Optoisolated inputs receive informations and safety flags :

- Probe heater overheating flag.
- Gas flow detection.
- LN<sub>2</sub> level monitoring (when option available).
- Probe heater power status flag (on/off).
- etc.

Eight optoisolated outputs (**PORT3**) transmit the control byte for the DAC that delivers the LN<sub>2</sub> heater control signal.

## Digital interface specifications

## 4.2

### Microcontroller :

8 bits 8032 microcontroller clocked at 11,05 MHz

### Program Memory :

Flash EPROM 64 K. A new firmware can be downloaded in this memory through the RS232 link.

### Sram :

32 Kilobytes

### Eeprom :

256 bytes for manufacturing informations storage (BBIS informations).

### Interface :

- Serial link to EUROTHERM controller :

9600 bauds, 1 start bit, even parity, 1 stop bit and three wires link. Baudrate can be changed by software with the «CO» command.

- Serial link to host computer :

9600 bauds, 1 start bit, even parity, 1 stop bit and three wires link.

### Isolation :

Optocouplers 2500 volt isolation between digital interface and power section.

### Power supply :

+5 volt, I < 1 ampere.

## **Commands and communication protocol**

**4.3**

All commands for the Eurotherm controller cross over the interface. The micro-controller looks at each received command and decides then for whom the command is intended (either for the interface itself or the Eurotherm controller). A command that is not an interface command is automatically transferred to the Eurotherm controller. If the command is processed by the Eurotherm, the controller answer is returned to the host computer via the interface.

## **Control characters**

**4.4**

Six non printing ASCII characters are used to control the messages that are exchanged between host computer and BVT3200.

Table 4.1. Control characters

NAME	HEX	FUNCTION
STX	02	Start of text
ETX	03	End of text
EOT	04	End of transmission
ENQ	05	Enquiry
ACK	06	Acknowledge
NACK	15	Negative acknowledge



**List of commands****4.5**

Table 4.2. List of commands

COMMANDS	R	W	COMMENT
AF	X	X	reads / writes gas flow delivery
CM	X		starts a ram test of the microcontroller (for test only)
CO	X	X	reads / writes communication speed (Interface <-> Eurotherm)
DL	X	X	reads the download transfer status/ initialises a download transfer
DT		X	DAC check (for test purpose only)
ES	X		reads the error status
HP	X	X	reads / writes heater power state ('1' or '0')
IS	X		reads interface status
NH	X	X	reads / writes LN <sub>2</sub> heater power level
NP	X	X	reads / writes LN <sub>2</sub> heater power state ('1' or '0')
P1	X	X	reads / writes port 1 (for test only)
P2	X	X	reads / writes port 2 (for test only)
P3	X		reads port 3 (for test only)
P4	X		reads port 4 (for test only)
SV	X		reads interface version (software, hardware and installed options)
RB		X	reads BBIS memory content
WB		X	writes to a BBIS memory location
WR		X	writes a record to the BVT3200
XR		X	transmit a hexadecimal record to the host

## Rs232 link characteristics

4.6

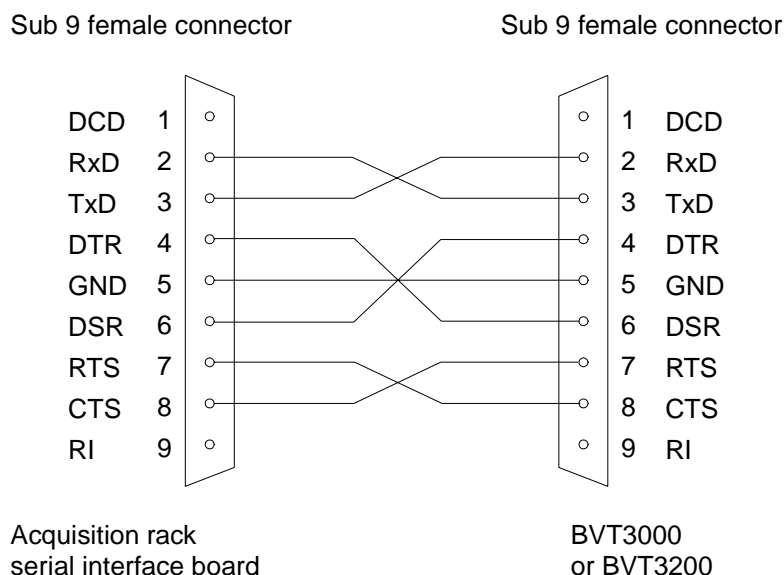
The serial link allows a host computer to communicate with the BVT3200. It is a three wires link with no hardware or software handshake. The communication parameters are 9600 bauds, 1 start bit, even parity, 1 stop bit. RS232 connector pin assignment and names are explained above in table "RS232 connector pin assignment" on page 18.

## Rs232 cable

4.7

A cable with two 9 pins female connectors is required to link the host computer to the BVT3200. The maximum recommended cable length is 10 m (30 feet). The cable shield is connected to the connector's case.

Figure 4.1. RS232 cable



## Authorised functions

4.8

The microcontroller detects automatically the installed optional board (LN<sub>2</sub> evaporator or LN<sub>2</sub> heat exchanger) and the devices connected on the front panel (exchanger or evaporator). The firmware authorizes only the use of the functions relative to the installed options. Let us suppose, for instance, the N2 exchanger is installed : you cannot use the evaporator functions. The answer to an unauthorized function will be a «**NACK**». The following table gives the different possible options and their authorised functions. In this table, «**X**» means authorised and a empty cell means unauthorised.

Table 4.3. *Authorised commands*

COMMANDS	STANDARD	WITH EVAPORATOR	WITH EXCHANGER	PROBLEM
AF	X	X	X	X
CM	X	X	X	
CO	X	X	X	
DL	X	X	X	
DT	X	X	X	
ES	X	X	X	
HP	X	X	X	
IS	X	X	X	X
NH		X		
NP		X		
P1	X	X	X	X
P2	X	X	X	X
P3	X	X	X	X
P4	X	X	X	X
SV	X	X	X	X
RB	X	X	X	X
WB	X	X	X	X
WR	X	X	X	X
XR	X	X	X	X

## Write

Syntax: EOT 0 0 0 0 STX **AF**>ABCD ETX BCC

Response: ACK

Description: This command allows to control the gas flow delivery.

Rules: The unit has four gas flow valves. ABCD represent the value of the delivery. Each character represent one valve state (a part of the maximum delivery) and can only be «0» or «1». The total delivery is the amount of the four individual deliveries. A NACK is send if one of these characters is not «0» or «1».

Table 1.1. "Flow rate versus command" on page 14 shows the different gas flow deliveries.

Example: If ABCD is set to «1100» (12 decimal), The delivery corresponds to 1600 litres per hour.

**NB**: At start the microcontroller reads the jumpers (JP7-10) and the gas flow is set as defined by the jumpers settings.

<b>JP7</b>	:	V1 (A)	JUMPER NOT SET	→	VALVE OPEN
<b>JP8</b>	:	V2 (B)	JUMPER SET	→	VALVE CLOSED
<b>JP9</b>	:	V3 (C)			
<b>JP10</b>	:	V4 (D)			

These jumpers are located between the valve block and the temperature controller.

**WARNING**: Space characters are not allowed.

## Read

Syntax: EOT 0 0 0 0 **AF** ENQ

Response: STX **AF** > Value ETX BCC

Description: This command allows to read the actual gas delivery.

Rules: Value is a 4 characters string. Table 1.1. "Flow rate versus command" on page 14 shows the different gas flow deliveries.

**Read**

Syntax: EOT 0 0 0 0 CM ENQ

Response: ACK if the RAM test has complete.  
NACK if the test failed.

Description : The CM command starts a complete microcontroller ram test.

WARNING : After the (ACK or NACK) answer the interface is always RESET.

### Write

Syntax : EOT 0 0 0 0 STX **CO** ABCDE ETX BCC

Response : ACK

Description : CO command allows to program the Eurotherm - interface speed communication. After power on, speed communication is set to 9600 Bauds.

Rules : ABCDE represent the baud rate. It is a five characters string. This string can have one of the following values :

A B C D E

1 9 2 0 0

\_ 9 6 0 0

\_ 4 8 0 0

\_ 2 4 0 0

\_ 1 2 0 0

**NB** : \_ represent the space character. It can be replaced by '0'.

### Read

Syntax : EOT 0 0 0 0 STX **CO** ENQ

Response : STX CO ABCDE ETX BCC

Description : It allows to read the Interface - Eurotherm communication speed.

Rules : «ABCDE» represent the baud rate. It is a 5 characters string. The string can have the following values :

A B C D E

1 9 2 0 0

\_ 9 6 0 0

\_ 4 8 0 0

\_ 2 4 0 0

\_ 1 2 0 0

**NB** : \_ represent the space character.

### Write

Syntax: EOT 0 0 0 0 STX **DL** val ETX BCC

Response: ACK if command issues.  
NACK in all other cases.

Description: DL initializes download. This command must be repeated two times successfully to enter in the mode which allows the host to transfer code.

Take care: Flash Eprom is erased on the second DL command.

On second DL1 command, regulation is interrupted. Heater, evaporator and gas flow are switched off. All the software user function are inaccessible.

Rules: Val can be «0» or «1».

- «0» stops download. If the download is in progress, a new one must be performed completely to make the BVT3200 run correctly.
- «1» initializes download. The «DL1» command must be send twice to start the process (FLASH memory erased).

### Read

Syntax: EOT 0 0 0 0 **DL** ENQ

Response: STX **DL** val ETX BCC

Description: Allows the user to get information about down-load.

Rules: Val = '0': No down-load in progress.  
Val = '1': Down-load in progress but flash eprom is not erased.  
Val = '2': Down-load in progress and flash eprom erased.

Syntax : EOT 0 0 0 0 DT state ETX BCC

Response : ACK

Description : DT starts a LN<sub>2</sub> DAC test.

Rules : state can be «0» or «1».

1 means test on.

0 means test off.



**Read**

Syntax: EOT 0 0 0 0 **ES** ENQ

Response: STX **ES** val ETX BCC

Description: Allows the user to get information about the last six errors.

Explanations: At each «ES» request, the last error code is sent and then reset. If more than six errors are memorised, the oldest error code is replaced by the new one. To erase all errors, one must send «ES» requests until response is «ES0».

The returned value «Val» is the error code. The different error codes are given in the table below.

**Write**

Syntax: EOT 0 0 0 0 STX **ES** val ETX BCC

Response: Always NACK.

Table 4.4. Error status description

VAL	SIGNIFICATION	COMMENT
0	NOERROR	no error in command
1	SYNTAX	unknown command/syntax error
2	checksum	checksum error
3	erasetfail	flash eprom erase error
4	programmfail	flash eprom program error
5	wrongrecordtype	no intel hex record
6	wrongaddress	program address out of range
7	wrongchecksum	checksum error intel hex
8	wrongtransmissioncheck	wrong eof record
9	wrongdatacount	byte counter error
10	noappsw	no application software
11	nobbis	no BBIS available
12	bbiscs1	BBIS checksum error block 1
13	bbiscs2	BBIS checksum error block 2
14	bbiscs3	BBIS checksum error block 3
15	bbiscs4	BBIS checksum error block 4

## Write

Syntax : EOT 0 0 0 0 STX **HP** state ETX BCC

Response : ACK If state equals «0» or «1»  
NACK In all other cases

Description : This command allows to switch ON or OFF the gas flow heating.

Rules : State can be «0» or «1».  
«1» switch the heater ON  
«0» switch the heater OFF  
All other values are ignored.

**WARNING** : Space characters are not allowed.

## Read

Syntax : EOT 0 0 0 0 **HP** ENQ

Response : STX **HP** state ETX BCC

Description : This command allows to read the heater's state.

Rules : State can be '0' or '1'.  
«1» means that heater is ON  
«0» means that heater is OFF

**NB** : after power on the heater is OFF.

**Read**

Syntax: EOT 0 0 0 0 **IS** ENQ

Response: STX **IS** > ABCD ETX BCC

Description: This command allows to read back the interface status.

Rules: The status word is made of sixteen bits, each one represents a particular function of the interface as detailed below. The 16 bits are sent as four hexadecimal numbers preceded by «>» to warn the computer that the data is hexadecimal. Digits ABCD are ASCII characters representing a hexadecimal digit (0-9, A-F).

Interface Status (IS) in the format (>ABCD)

Table 4.5. Interface status

DIGIT	BIT	SIGNAL NAME	FUNCTION
D1	0	heater on	1= heater is ON
D2	1	not used	always 0
D3	2	evap conn	1 = evaporator connected
D4	3	missing gas flow	1 = missing gas flow
C1	4	overheating	1 = heater overheating
C2	5	exch conn	1 = exchanger connected
C3	6	LN <sub>2</sub> refill	1 = refill LN <sub>2</sub> tank
C4	7	LN <sub>2</sub> empty	1 = LN <sub>2</sub> tank is empty.
B1	8	evaporator status	1 = LN <sub>2</sub> heater is on
B2	9	not used	1 always
B3	10	booster connected	1 = BVTB3500 present
B4	11	reserved	0 always
A1	12	reserved	0 always
A2	13	reserved	0 always
A3	14	reserved	0 always
A4	15	reserved	0 always

### Write

Syntax : EOT 0 0 0 0 STX **NH** Value ETX BCC

Response : ACK

Description : This command allows to control the LN<sub>2</sub> heater power (Evaporator).

Rules : The value from 0 up to 100%, is defined as a string up to 5 characters long. The string can begin with 1 to 5 spaces or «0». After power on, the initial value is set to 0 (the nitrogen heater is OFF).

### Read

Syntax : EOT 0 0 0 0 **NH** ENQ

Response : STX **NH** Value ETX BCC

Description : This command allows to read back LN<sub>2</sub> heater power.

Rules : Value from 0 to 100%, is a string up to 5 characters long. The string can begin with 1 to 5 spaces or «0».

**NB** : Value is a DECIMAL code.

### Write

Syntax : EOT 0 0 0 0 STX **NP** state ETX BCC

Response : ACK

Description : Allows to switch nitrogen heater power ON or OFF.

Rules : State can be «0» or «1».

«1» switch LN<sub>2</sub> heater ON.

«0» switch LN<sub>2</sub> heater OFF.

**WARNING**: Space characters are not allowed.

### Read

Syntax : EOT 0 0 0 0 **NP** ENQ

Response : STX **NP** State ETX BCC

Description : Allows to read Nitrogen Power.

Rules : State can be «0» or «1».

State at «1» means that LN<sub>2</sub> heater is ON.

State at «0» means that LN<sub>2</sub> heater is OFF.

NB : After power on the nitrogen heater power is at «0».

This port represents the main status of the BVT3200 unit.

Port 1 is described in the following table

Table 4.6. Port 1 definition

BIT	NAME	FUNCTION
0	heater	1 = Probe heater is ON
1	aux1	Unused
2	evaporator	1 = LN <sub>2</sub> heater is ON (with option)
3	aux2	Unused
4	valve1	1 = Valve 1 open
5	valve2	1 = Valve 2 open
6	valve3	1 = Valve 3 open
7	valve4	1 = Valve 4 open

## Write

Syntax : EOT 0 0 0 0 STX **P1** AB ETX BCC

Response : ACK

Description : Allows to write directly to port 1.

Rules : The first character represents the state of port 1 bits 4 to 7. The second character represents the state of the bits 0 to 3. The characters are hexadecimal.

## Read

Syntax : EOT 0 0 0 0 **P1** ENQ

Response : STX **P1** > ABCD ETX BCC

Description : Allows direct read access to port 1.

Rules : A and B are always «0». The third character represents the state of port 1 bits 4 to 7. The fourth character represents the state of the bits 0 to 3. All the characters are hexadecimal.

The power level applied to the LN<sub>2</sub> evaporator is set by an analog control signal delivered by a 8 bit DAC (Digital to Analog Converter). Port 2 provides the bits for LN<sub>2</sub> control DAC :

Table 4.7. Port 2 definition

BIT	NAME	FUNCTION
0	1LN <sub>2</sub>	DAC bit 0
1	2LN <sub>2</sub>	DAC bit 1
2	3LN <sub>2</sub>	DAC bit 2
3	4LN <sub>2</sub>	DAC bit 3
4	5LN <sub>2</sub>	DAC bit 4
5	6LN <sub>2</sub>	DAC bit 5
6	7LN <sub>2</sub>	DAC bit 6
7	8LN <sub>2</sub>	DAC bit 7

**Write**

Syntax : EOT 0 0 0 0 STX **P2** AB ETX BCC

Response : ACK

Description : Allows direct write access to port 2.

Rules : The first character represents the state of port 2 bits 4 to 7. The second character represents the state of the bits 0 to 3. The characters are hexadecimal.

**Read**

Syntax : EOT 0 0 0 0 **P2** ENQ

Response : STX **P2** > ABCD ETX BCC

Description : Allows direct read access to port 2.

Rules : A and B are always «0». The third character represents the state of port 2 bits 4 to 7. The fourth character represents the state of the bits 0 to 3. All the characters are hexadecimal.

Port 3 allows to read the internal status of the BVT3200.

It is composed as follows:

Table 4.8. Port 3 definition

BIT	NAME	FUNCTION
0	heater on	1 = probe heater is ON
1	booster connected	1 = BVTB3500 present
2	evap conn	1 = evaporator device is connected
3	no gas	1 = missing gas flow
4	overheating	1 = overheating on probe heater
5	exch conn	1 = Exchanger connected
6	LN <sub>2</sub> refill	1 = LN <sub>2</sub> tank is almost empty
7	LN <sub>2</sub> empty	1 = LN <sub>2</sub> tank is empty

## Read

Syntax : EOT 0 0 0 0 **P3** ENQ

Response : STX **P3** > ABCD ETX BCC

Description : Allows direct read access to port 3.

Rules : A and B are always «0». The third character represents the state of port 3 bits 4 to 7. The fourth character represents the state of the bits 0 to 3. All the characters are hexadecimal.



Port 4 allows to read the internal status of the BVT3200 and sets the gas flow rate at power on.

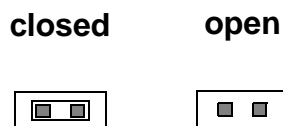
It is composed as follows:

Table 4.9. Port 4 definition

BIT	NAME	FUNCTION
0	unused	
1	unused	
2	unused	
3	evap_on	1 = evaporator heater on
4	V1	jumper JP10
5	V2	jumper JP9
6	V3	jumper JP8
7	V4	jumper JP7

When a jumper is placed in position 1 it means that the valve is open at power on.

Figure 4.2. Valve jumpers settings



**Read**

Syntax : EOT 0 0 0 0 P4 ENQ

Response : STX P4 > ABCD ETX BCC

Description : Allows direct read access to port 4

Rules : A and B are always «0». The third character represents the state of port 3 bits 4 to 7. The fourth character represents the state of the bits 0 to 3. All the characters are hexadecimal.

### Write

Syntax : EOT 0 0 0 0 STX **R B** adr\_e2prom A1 A0 ETX BCC

Response : STX **R B** > D0 D1 ETX

NACK if command can't issue.

Description : RB command allows to read a single byte in a BBIS E2PROM

Rules : A1, A0 are values from '0' up to 'F' representing the byte address in the E2PROM.

adr\_E2prom is a value from '0' up to '7' representing the I2C bus address of the E2PROM

- 0: Address unused
- 1: BVT3200 motherboard address
- 2: BVTB3500 (Booster) address
- 3: Address unused
- 4: Address unused
- 5: Address unused
- 6: Address unused
- 7: Address unused

All other values generate a NACK response

**Read**

Syntax : EOT 0 0 0 0 **SV** ENQ

Response : STX **SV** Version ETX BCC

Description : Version is a 5 characters (SSHHO). This string splits in:

- **SS** is the SOFT version
- **HH** is the HARDWARE version
- **O** indicates the installed OPTIONS

**Example** : The string received is:

**Hex** : 02H 53H 56H 30H 31H 32H 33H 35H 02H 37H

**Ascii** : STX 'S' 'V' '0' '1' '2' '3' '5' ETX BCC

It means: SOFTWARE Version 0.1

HARDWARE Version 2.3

OPTIONS 5

The different options identifications are defined as follows:

- '1': Not used.
- '2': LN<sub>2</sub> Evaporator option.
- '3': Not used.
- '4': LN<sub>2</sub> Exchanger option.
- '5': Not used.
- '6': Problem detected.

### **Write**

Syntax : EOT 0 0 0 0 STX **W B** adr\_e2prom A1 A0 D1 D0 ETX BCC

Response : ACK if command issues  
NACK in all other cases

Description : WB command allows to write a single byte on a BBIS E2PROM.

Rules : A1, A0 are values from '0' up to 'F' representing the address in the E2PROM.

D1, D0 are values from '0' up to 'F' representing the value to be written.

adr\_e2prom is a value from '0' up to '7' representing the I2C bus address of the E2PROM

- 0: Address unused
- 1: BVT3200 motherboard address
- 2: BOOSTER address
- 3: Address unused
- 4: Address unused
- 5: Address unused
- 6: Address unused
- 7: Address unused

All other values generates a NACK response

Intel-Hex format is used to download the firmware on flash-eprom. The file to transfer is generated with OHS51.EXE. Its file extension is «.HEX». This file is composed by several records. Each record is composed as shown below :

: L L A A A A T T D D D . . . . . D D C C Cr Lf

Table 4.10. Record format

FIELD	LENGTH	SIGNIFICATION
: (3A)	1	Record start
L	2	Record length
A	4	Record address
T	2	Type (00: Data record, 01: EOF record)
D	LL	Data's
C	2	Checksum

Write

Syntax : EOT 0 0 0 0 STX **TR** Rec ETX BCC

Response : ACK if down-load initialized and the record processing issues.  
NACK in all other cases

Description : Allows to transfer records extract from a «.hex» file to the BVT3X00.

Rules : Rec value represents an intel-hex record. The first character «:» (3A), Cr and Lf are not transmitted.

### Write

Syntax : EOT 0 0 0 0 STX **X R** Val ETX BCC

Response : STX 0 0 0 0 X R Rec BCC

Description : This command is useful to save a working software before to process a new download.

**Take care** : if Val = 1, regulation is interrupted. Heater, evaporator and gas flow are switched off. All the software user function are inaccessible.

Rules : Val = 0: Stops the up-load process.

Val = 1: Initializes the up-load process.

Val = 2: Authorizes the BVT3200 to send the next record.

Val = 3: Ask the BVT3200 to send the same record again.

The up-load process is initialized by receiving «XR1» from the host computer. The BVT3200 sends the first Intel-hex record. The BVT3200 waits then for «XR2» to continue. This command authorizes the BVT3200 to send the next record. This handshake continues until the BVT3200 sends the last record which is «0 0 0 0 0 0 1 F F». Host computer must detect it. Then, BVT3200 sends an «XR0» requests to terminate up-load process and return to normal mode.

If BVT3200 receives an «XR3» command, the previous record is sent again.

An «XR0» Command must be sent to terminate the up-load sequence and return to normal mode.

# Technical specifications

# 5

## Specifications

5.1

Table 5.1. BVT3200 specifications

<b>Temperature controller</b>	Eurotherm Model 2416 (display units in K or °C).
<b>Sensors</b>	<ul style="list-style-type: none"><li>· T thermocouple with compensated connector.</li><li>· BTO2000 or PT100.</li></ul>
<b>Temperature range</b>	<ul style="list-style-type: none"><li>· 35 °C to 200 °C without special accessory</li><li><u>Low temperature limit</u></li><li>· - 5° C with BCU05 cooler.</li><li>· -150 °C with LN<sub>2</sub> exchanger or LN<sub>2</sub> evaporator.</li><li><u>High temperature limit</u></li><li>· 600 °C with power booster BVTB3500</li></ul>
<b>Temperature stability</b>	<ul style="list-style-type: none"><li>· 0.01 °C/°C for sample temperature between 0 °C and 50 °C, using a BTO2000 and BCU05</li><li>· 0.1 °C/°C without BTO2000</li></ul>
<b>Heater power</b>	135 W (48 V max. on 12 Ω probe heater). Output current limitation at 6A max.
<b>Gas inlet</b>	<ul style="list-style-type: none"><li>· Dry air or nitrogen 4 bar mini and 7.5 bar maxi.</li><li>· Dry air, dew point &lt; 5 °C for operation above room temperature.</li><li>· Dry air, dew point &lt; -50 °C for operation with BCU05 cooler</li></ul>
<b>Gas flow rate</b>	200 l/h to 2000 l/h. Fifteen values available. Controlled by software.
<b>Control</b>	Computer control via RS232 interface.
<b>Software control</b>	By EDTE version 980324
<b>Options</b>	<ul style="list-style-type: none"><li>· LN<sub>2</sub> evaporator (210W, with optional printed circuit board and 400 VA power supply).</li><li>· LN<sub>2</sub> exchanger (with optional printed circuit board).</li><li>· BCU05 gas cooler.</li><li>· BVTB3500 External Power Booster</li><li>· BVT3900 Probe heat exchanger</li></ul>

## Technical specifications

Table 5.1. BVT3200 specifications

<b>Power requirements</b>	<ul style="list-style-type: none"><li>· 5V / 1A</li><li>· 24V / 1.5A for Eurotherm unit</li><li>· 24V / 0.5A for pneumatic</li><li>· -15V / 0.5A</li><li>· +15V / 0.5A</li><li>· 48V / 4.1A standard</li><li>· 48V / 8.3A with LN<sub>2</sub> evaporator option board</li></ul>
<b>Weight</b>	1.5 kg without option board
<b>Dimensions</b>	<ul style="list-style-type: none"><li>- 61 mm length</li><li>- 262 mm height</li><li>- 246 mm depth.</li></ul>

## Safety fuses

## 5.2

Some important electronic functions are fuse protected. To replace a blown fuse, turn off the BVT3200 and disconnect the main power cord. A faulty fuse must always be replaced with the same type.

Table 5.2. Fuses values

Fuses	Value	Protection for
F1	5 AT	Probe heater resistor
F3	10 AT	48V power supply







# Figures

<b>1 Description</b>	<b>7</b>
Figure 1.1. BVT3200 block diagram .....	8
Figure 1.2. Parts location (top view) .....	9
Figure 1.3. BVT3200 front panel .....	12
Figure 1.4. Gas flow circuit .....	13
Figure 1.5. Heater connector (Front view) .....	15
Figure 1.6. Pt100 connector (front view) .....	16
Figure 1.7. Thermocouple connector (Front view) .....	17
Figure 1.8. RS232 male connector (Front view) .....	18
Figure 1.9. N <sub>2</sub> connector (Front view) .....	19
Figure 1.10. BCU05 connector .....	19
Figure 1.11. BVTB 3500 connector (Front view) .....	20
<b>2 Options</b>	<b>21</b>
Figure 2.1. Exchanger principle .....	22
Figure 2.2. Evaporator principle .....	25
Figure 2.3. Option installation .....	27
Figure 2.4. BCU05 principle .....	28
<b>3 Configuration</b>	<b>29</b>
<b>4 Remote interface control</b>	<b>31</b>
Figure 4.1. RS232 cable .....	34
Figure 4.2. Valve jumpers settings .....	49
<b>5 Technical specifications</b>	<b>55</b>



# Tables

<b>1</b>	<b>Description</b>	<b>7</b>
Table 1.1.	Gas flow rate versus command .....	14
Table 1.2.	Heater connector pin assignment .....	15
Table 1.3.	Pt100 connector pin assignment .....	16
Table 1.4.	Thermocouple T pin assignment .....	17
Table 1.5.	RS232 connector pin assignment .....	18
Table 1.6.	Evaporator connector pin assignment .....	19
Table 1.7.	BCU05 connector pin assignment .....	19
Table 1.8.	BVTB 3500 connector pin assignment .....	20
<b>2</b>	<b>Options</b>	<b>21</b>
<b>3</b>	<b>Configuration</b>	<b>29</b>
<b>4</b>	<b>Remote interface control</b>	<b>31</b>
Table 4.1.	Control characters .....	32
Table 4.2.	List of commands .....	33
Table 4.3.	Authorised commands .....	35
Table 4.4.	Error status description .....	41
Table 4.6.	Port 1 definition .....	46
Table 4.7.	Port 2 definition .....	47
Table 4.8.	Port 3 definition .....	48
Table 4.9.	Port 4 definition .....	49
Table 4.10.	Record format .....	53
<b>5</b>	<b>Technical specifications</b>	<b>55</b>
Table 5.1.	BVT3200 specifications .....	55
Table 5.2.	Fuses values .....	56



